

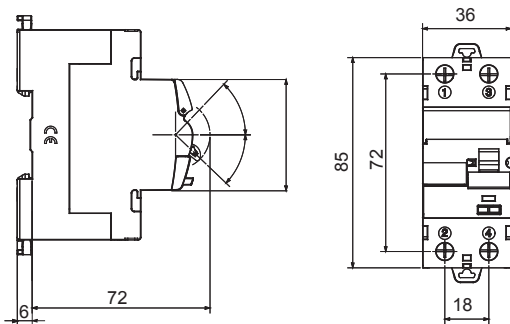

Omschrijving	AARDLEKSCHAKELAAR
Code	IDP
Aant. polen	2P
Aant. modules	2
Nominale stroom	63 A
Nominale aardlekstroom	100 mA
Type	A
Nominale spanning (IEC/EN 61008-1, 61008-2-1)	230/240 V

Standaard	IEC/EN 61008-1, IEC/EN 61008-2-1	Nominale frequentie (Hz)	50/60 Hz
Isolatievoltage (Ui)	500 V	Nominale impuls schokbestendigheidsspanning (Uimp)	4 kV
Overspannings categorie	III	Immunitieitsniveau (8/20 μs)	250 A
Sectie rigide kabel	<=1x35 - <=2x16 - <=1x16+2x10 mm²	Sectie flexibele kabel	<=1x35 - <=2x16 - <=1x16+2x10 mm²
Nominale aandraaikoppel	3 Nm	Dubbele verbinding	JA (stroomopwaarts en stroomafwaarts)
Bedrijfstemperatuur	-25 +60 °C (40 °C met onderbelasting)	Opslagtemperatuur	-40 +70 °C
Elektrische duurzaamheid	≥ 10.000	Mechanische duurzaamheid	≥ 20000
Comptabiliteit aanvullingen	Ja	Comptabiliteit ReStart	Ja
Montage positie	Elke		

DIMENSIONAL



WIRING DIAGRAM



STANDARDS/APPROVALS

