



Omschrijving	AARDLEKSCHAKELAAR
Code	BD
Aant. polen	4P
Aant. modules	3,5
Nominale stroom	25 A
Nominale aardlekstroom	30 mA
Type	A
Nominale spanning (IEC/EN 61009-1 app. G, IEC/EN 61009-2-1 app. G)	400 V

Standaard	IEC/EN 61009-1 app. G, IEC/EN 61009-2-1 app. G	Nominale frequentie (Hz)	50/60 Hz
Isolatievoltage (Ui)	500 V	Nominale impuls schokbestendigheidsspanning (Uimp)	4 kV
Overspannings categorie	III	Immunitieitsniveau (8/20 μs)	250 A
Sectie rigide kabel	Max. 35 mm ²	Sectie flexibele kabel	Max. 35 mm ²
Bedrijfstemperatuur	-25 +40 °C	Opslagtemperatuur	-40 +70 °C
Nominale aandraaikoppel	2 Nm	Montage positie	Elke

DIMENSIONAL



WIRING DIAGRAM

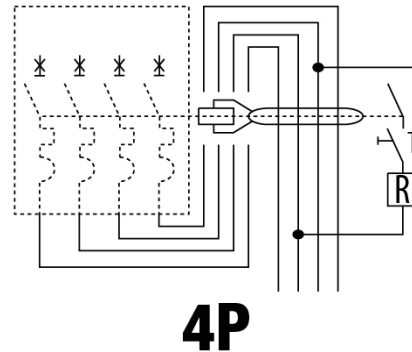

STANDARDS/APPROVALS

