

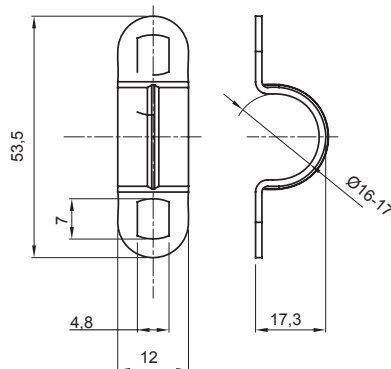

Systems of accessories for electrical installations used for residential, tertiary and industrial applications. The system consists of fasteners for pipes and cables, cable fittings, accessories for rigid pipes (RK Series) and flexible conduit (DF Series). The system include also a wide variety of cable ties (52FS Range) and terminal blocks (44 Range).

Material	Galvanised steel	Internal Ø (mm)	16-17
Hole dimension (mm)	7x4	Description	U-Bolt
For external conduits (mm)	16-17	Type	With two holes
Electrocod	21211		

DIMENSIONAL



STANDARDS/APPROVALS

