



Systems of accessories for electrical installations used for residential, tertiary and industrial applications. The system consists of fasteners for pipes and cables, cable fittings, accessories for rigid pipes (RK Series) and flexible conduit (DF Series). The system include also a wide variety of cable ties (52FS Range) and terminal blocks (44 Range).

Colour	Grey RAL 7035	IP degree	-
Material	Shockproof polymer	Fixing	Post bracket
For external conduits (mm)	16	Glow Wire Test	750 °C
Wall-conduit axis distance (mm)	20	Operating temperature	-5 +60 °C
Type of material	Halogen free in compliance with EN 50642	Electrocod	21221
Standard	EN 61386-1 (when applicable)		

BEHAVIOUR WITH CHEMICAL AND ATMOSPHERIC AGENTS

Saline solution	Acids		Bases		Solvents				Mineral oil	UV rays
	Concentrated	Diluted	Concentrated	Diluted	Hexane	Benzol	Acetone	Ethyl alcohol		
Resistant	Limited resistance	Limited resistance	Resistant	Resistant	Resistant	Resistant	Resistant	Resistant	Resistant	Limited resistance

DIMENSIONAL

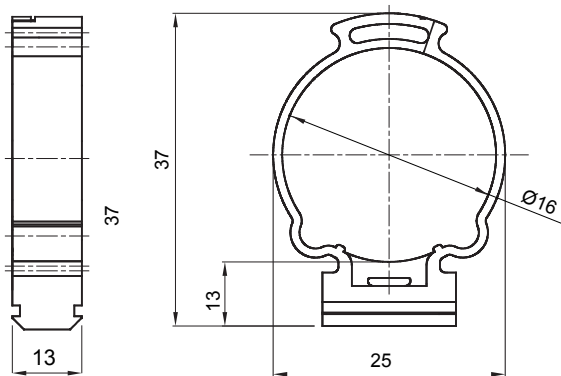

TECHNICAL SYMBOLOGY

IP

GWT

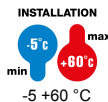

HF

Halogen free in compliance with EN 50642

STANDARDS/APPROVALS

