

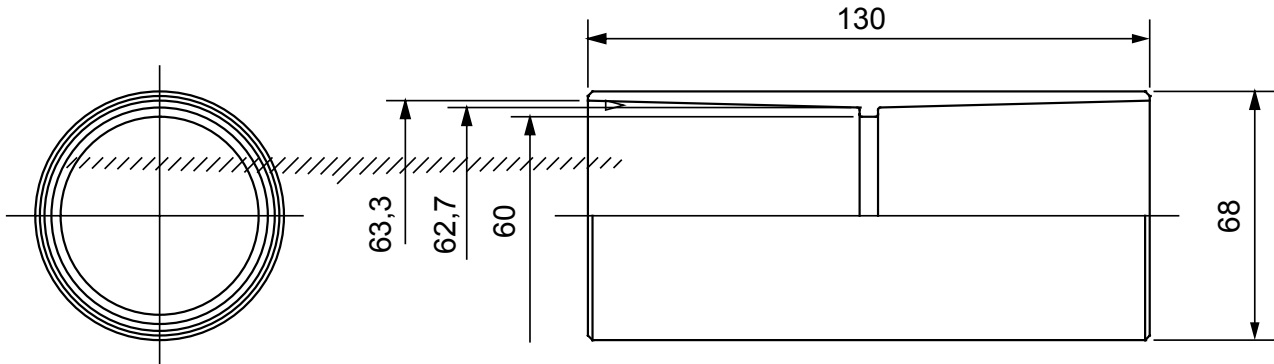

Routing components for rigid protective conduits with IP40 and IP67 protection degree.

| | | | |
|-----------------|---------------|------------------|--|
| Colour | Grey RAL 7035 | IP degree | IP40 |
| Conduits Ø (mm) | 63 | Type of material | Halogen free in compliance with EN 50642 |
| Electrocod | 21221 | | |

DIMENSIONAL



TECHNICAL SYMBOLOGY

IP

HF
HALOGEN FREE

IP40

STANDARDS/APPROVALS

