



Watertight enclosure for emergency use and special applications with rail DIN. It is available in red RAL 3000 or grey RAL7035 colours. Thanks to the emergency hammer, available as an accessory, sealable mask and halogen free materials are ideally suited for applications in areas open to public.

Rated current (A)	125	Insulation class	II
Colour	Grey RAL 7035	Outer dim. LxHxD (mm)	108x180x100
IP degree	IP55	Installation	Wall mounting
Material	Technopolymer	Mechanical resistance	IK08
Rated voltage (V)	400	Glow Wire Test	650 °C
Operating temperature	-25 +60 °C	Type of material	Halogen-free in compliance with EN 60754-2
Electrocod	0321	Thermo-pressure with ball	70 °C
Standard	EN 60670-1 (CEI 23-48) IEC60670-24 CEI 23-49	Insulation voltage	750 V
Dispersible power (W)	12	No. of modules EN 50022	4

BEHAVIOUR WITH CHEMICAL AND ATMOSPHERIC AGENTS

Saline solution	Acids		Bases		Solvents				Mineral oil	UV rays
	Concentrated	Diluted	Concentrated	Diluted	Hexane	Benzol	Acetone	Ethyl alcohol		
Resistant	Not resistant	Resistant	Resistant	Resistant	Limited resistance	Not resistant	Not resistant	Limited resistance	Limited resistance	Limited resistance

DIMENSIONAL

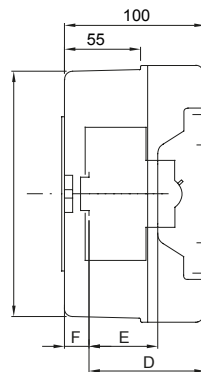
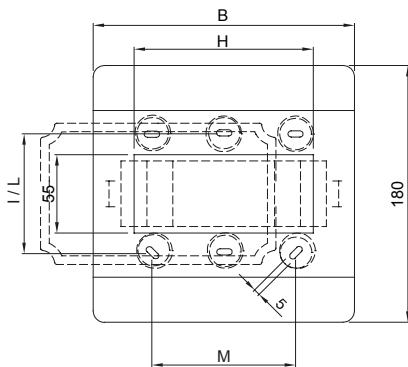

	GW 42 204 GW 42 206 GW 42 207	GW 42 202 GW 42 208	GW 42 203
B	108	180	180
A'	172	172	172
B'	100	172	172
D	75	75	-
E	48	48	-
F	12,8	12,8	-
H	55	125	125
I	84	-	-
L	-	138	138
M	-	100	100

TECHNICAL SYMBOLOGY



II

IP

IP55

IK

IK08

GWT

650 °C

INSTALLATION



-25 +60 °C

HF
HALOGEN FREE

Halogen-free in compliance with EN 60754-2



70 °C

STANDARDS/APPROVALS

