

A complete, versatile system of modular containers, perfectly integrable in the SYSTEM domestic range and able to meet the high protection installation requirements of the residential, commercial and industrial sectors. The 27 COMBI range is available both in the IP40 version and in watertight versions with IP55, IP65 and IP66 degree of protection, recommended for all outdoor applications which are subjected to extreme atmospheric conditions.

Description	For push button	No. gangs	12
Colour	Grey RAL 7035	Type of knockout holes	Removable with tool
Side entries	4xØ 23	Top entries	3xØ 23
Bottom entries	3xØ 23	IP degree	IP66
Insulation class	II	Mechanical resistance	IK07
Lid screws	Stainless steel	Torque screws tightening	0.8 Newton/meter
Outer dim. LxHxD (mm)	264x171x65	Glow Wire Test	650 °C
Thermo-pressure with ball	70 °C	Standard	EN 60670-1
Installation temperature	-25 +60 °C	Electrocod	0212

BEHAVIOUR WITH CHEMICAL AND ATMOSPHERIC AGENTS

Saline solution	Acids		Bases		Solvents				Mineral oil	UV rays
	Concentrated	Diluted	Concentrated	Diluted	Hexane	Benzol	Acetone	Ethyl alcohol		
Resistant	Not resistant	Resistant	Resistant	Resistant	Limited resistance	Not resistant	Not resistant	Limited resistance	Limited resistance	Limited resistance

DIMENSIONAL

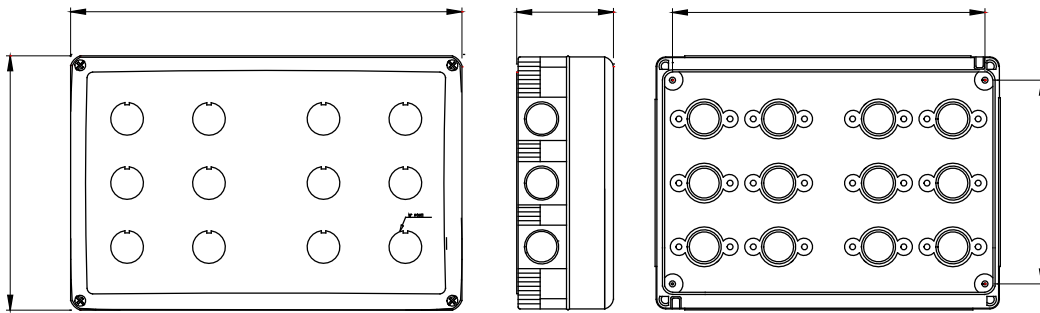

TECHNICAL SYMBOLOGY



IP
IP66



II

IK
IK07

GWT
650 °C

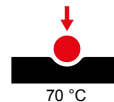

70 °C

STANDARDS/APPROVALS

