



Description	Motor switch
Rated operating voltage (Ue)	220 ... 690 V AC
Rated frequency (f)	50/60 Hz
Rated operating current (Ie)	32A
Setting range (It)	25...32 A
Number of poles	3P
No. modules	2.5

#### ELECTRICAL CHARACTERISTICS

Standard	IEC/EN 60947-2
Insulation voltage (Ui)	690 V
Rated impulse withstand voltage (Uimp)	6 kV
Overvoltage category	III
Short circuit breaking capacity (Icu)	25 kA (4kA 500V, 3kA 690V)
Short circuit breaking capacity (Ics)	12,5 kA (3kA 500V, 2kA 690V)
Max. back-up fuse, if Icp > Icu	80kA 230V, 63kA 400V, 50kA 500V, 50kA 690V
Power dissipation per pole	2,5 W

#### PROTECTIONS

Type of protection	Thermo magnetic
Tripping indication	The trip of the protection is signalled by the intermediate position of the START and STOP buttons

#### MECHANICAL FACTS

Mounting position	Any
Mechanical endurance (O-C cycle number)	100000
Electrical endurance (O-C cycle number)	100000 (AC-3)
IP degree	IP20
Pollution rating	3
Section rigid cable	<=10 mm <sup>2</sup>
Section flexible cable	<=6 mm <sup>2</sup>
Max. conductor stripping length	10 mm
Rated tightening torque	2 Nm
Operating temperature	-25 +60 °C
Stocking temperature	-25 +70 °C

#### DIMENSIONAL

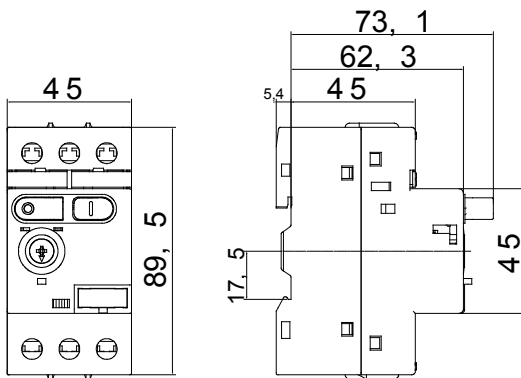

#### WIRING DIAGRAM

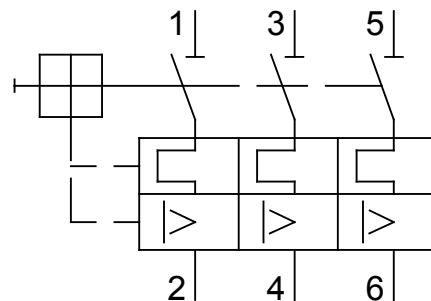

#### STANDARDS/APPROVALS

