



DAHLIA
ESSENTIAL SIMPLICITY

GEWISS

DAHLIA is the **wiring device range** designed by Gewiss with an elegant and timeless style that complements the decor of your home with **minimal shapes**.

New Products for 2018

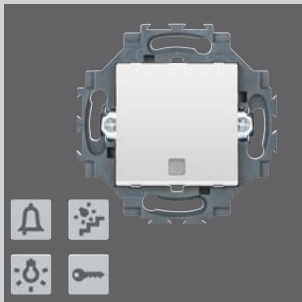

Interchangeable symbols

Switches and push-buttons are now available also in the version with backlit replaceable neutral lens, pre-arranged with an amber LED for night-time localization or to display the status of the load commanded. Lens are available in a wide set of functions.

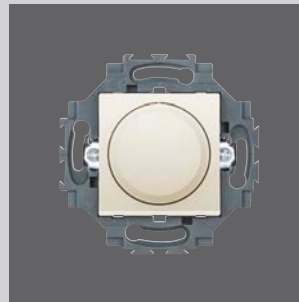

Universal dimmer

The Dahlia range includes a 160W universal rotating electronic regulator with a 2-way switch, to control dimmable LED and halogen lamps, and electronic transformers.

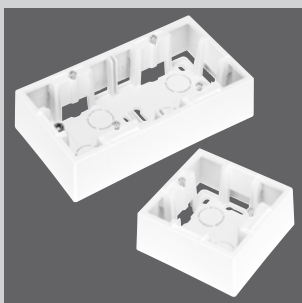

Wall-mounting boxes

Wall-mounting boxes for 1-gang and 2-gang Dahlia plates are available in white and with IP40 protection. They can be installed vertically or horizontally.

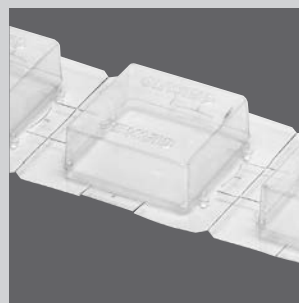

Paint protection

Transparent protective covers completely protect Dahlia components during painting and finishing projects. With a simple snap-on system for easy assembly and removal.

Colors



White



Ivory



Hemp



Cream



Light Grey



Dark Grey



Anthracite Grey

Modularity



1 gang



2 gang



3 gang



4 gang



5 gang



Double

Technical benefits

SWITCHES

SCREWLESS

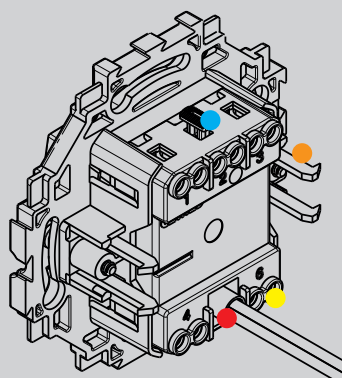

- LED housing
- Quick wiring terminals with color-coded cable entries

ENERGY SOCKETS

SCREWLESS

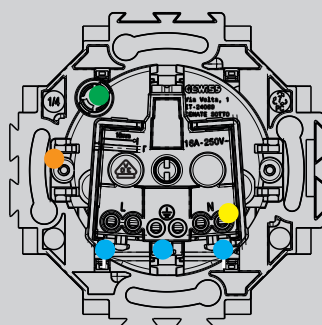

- Collar guide for quick cable insertion (up to 2.5 mm²)
- Socket-outlets pre-arranged for LED lamp

WITH SCREWS

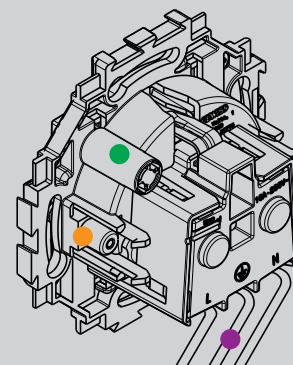

- Space-saving with side mounted terminals (up to 2.5mm² cable)
- Installation flexibility with claw or screw system