

# SMART PRO 2.0

# GEWISS

## GWP2909

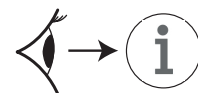
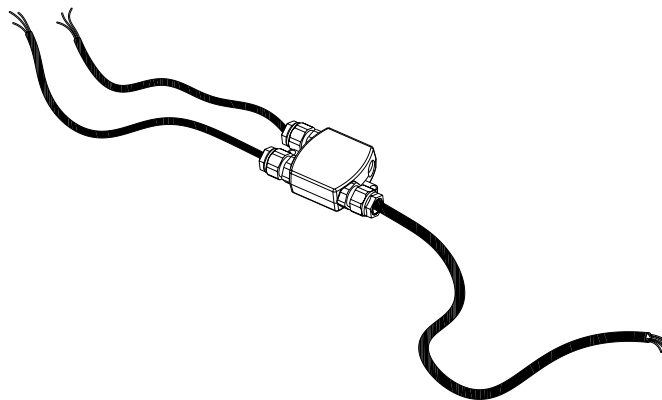

IP68



+50°C  
-30°C

I = Max 0,7A  
U<sub>out</sub> = Max 600V<sub>~</sub>

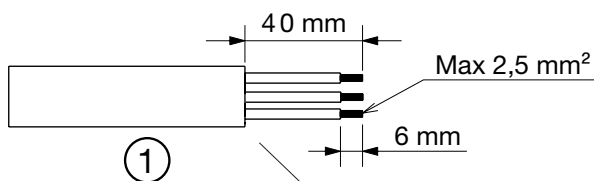
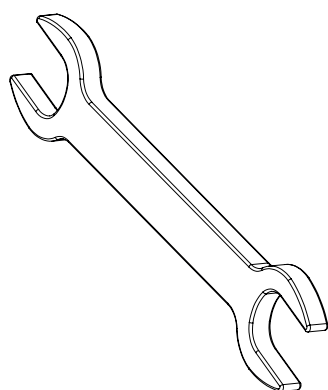
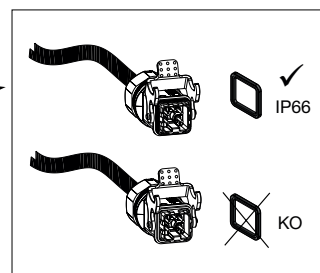
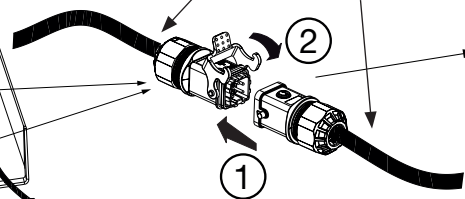
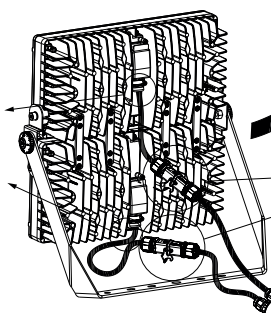
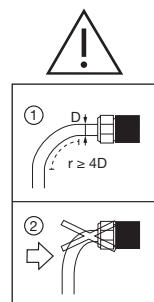
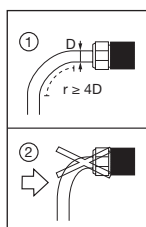

4 Nm

Ø 7 ÷ 14,4 mm

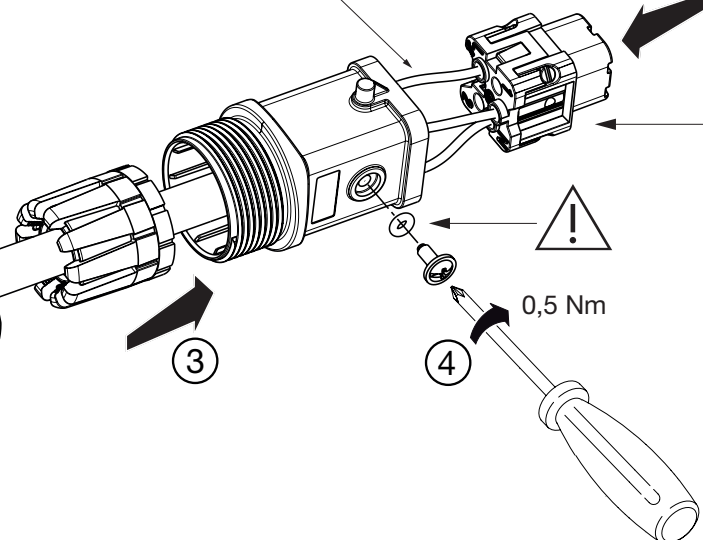

0,5 Nm

!	
L	L
N	N
⊕	⊕

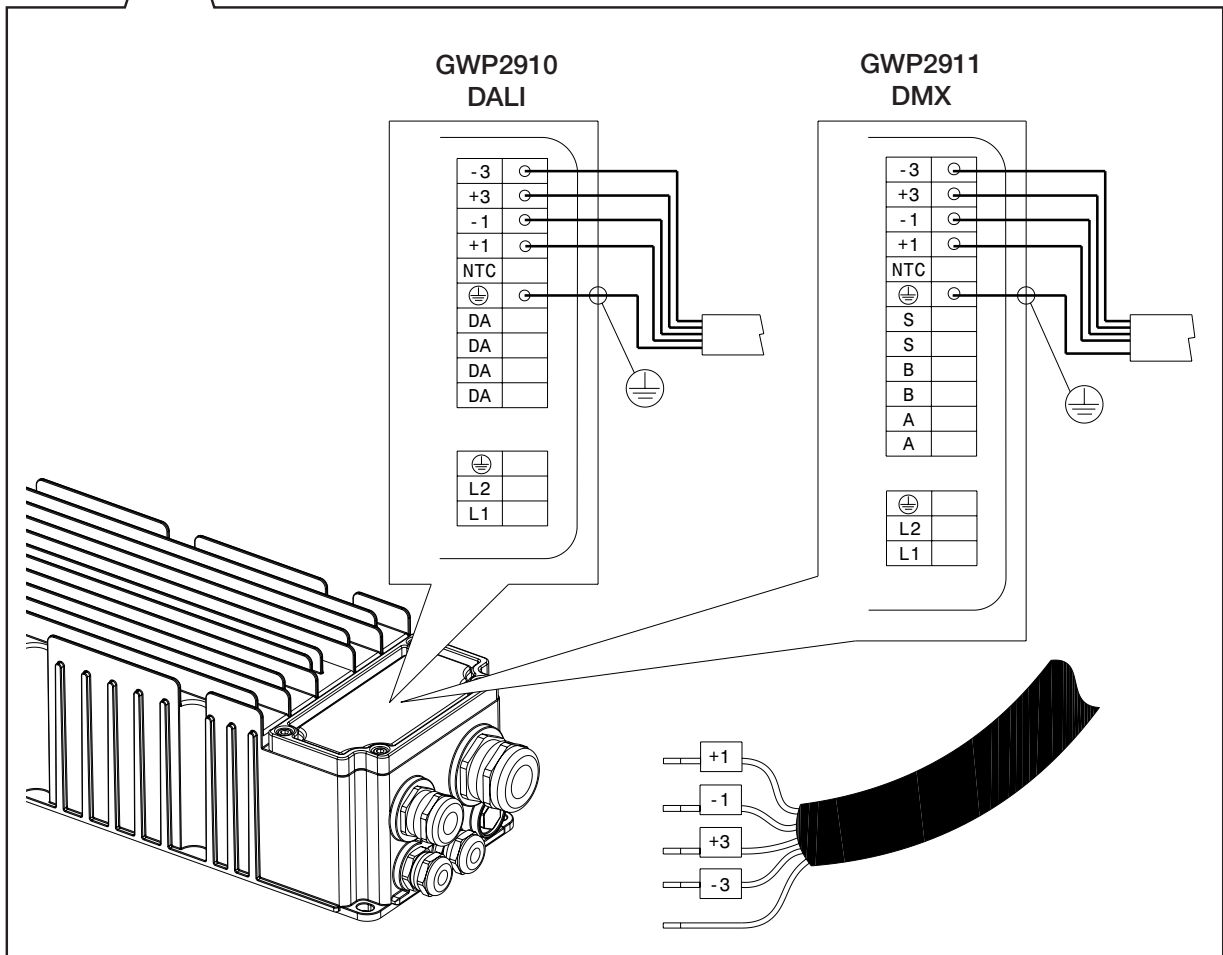
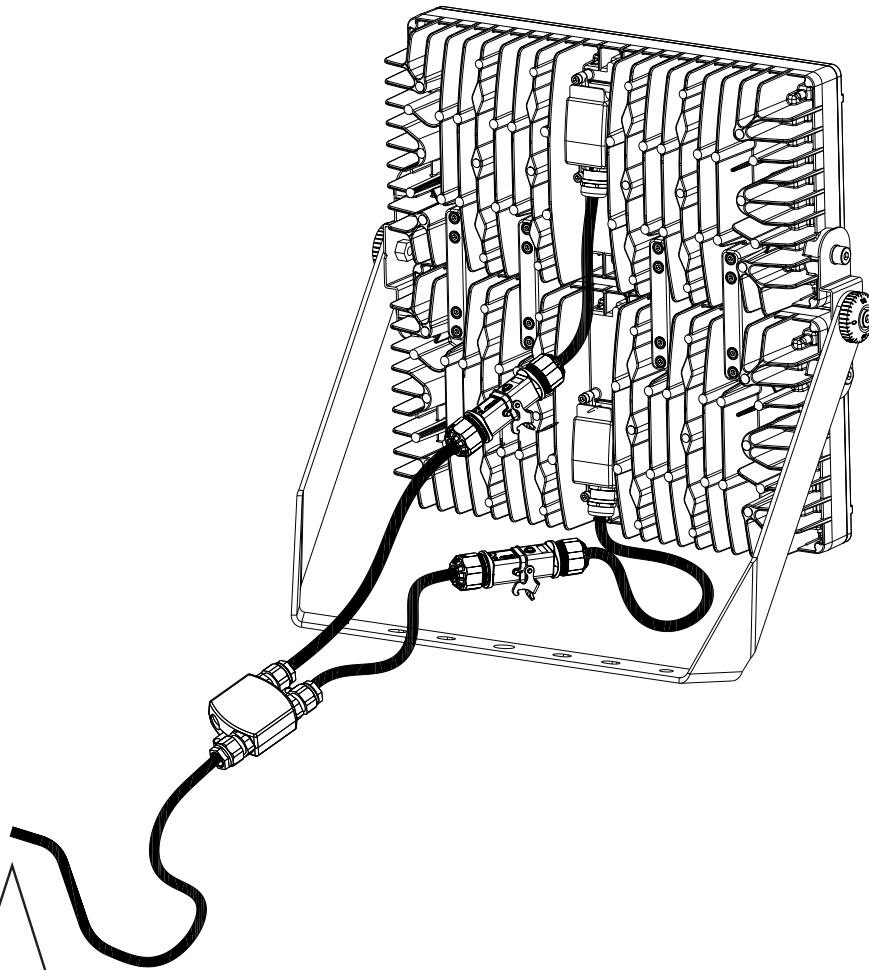

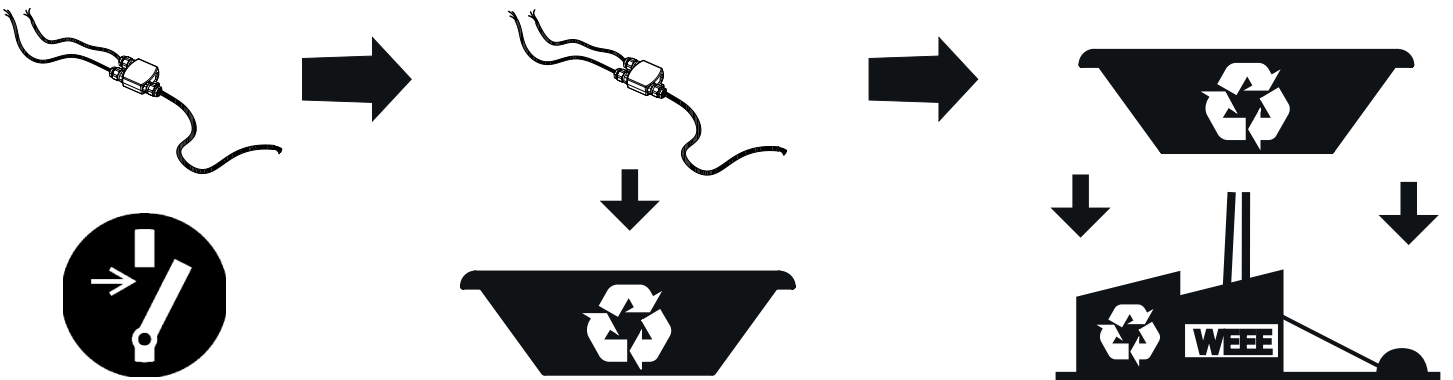
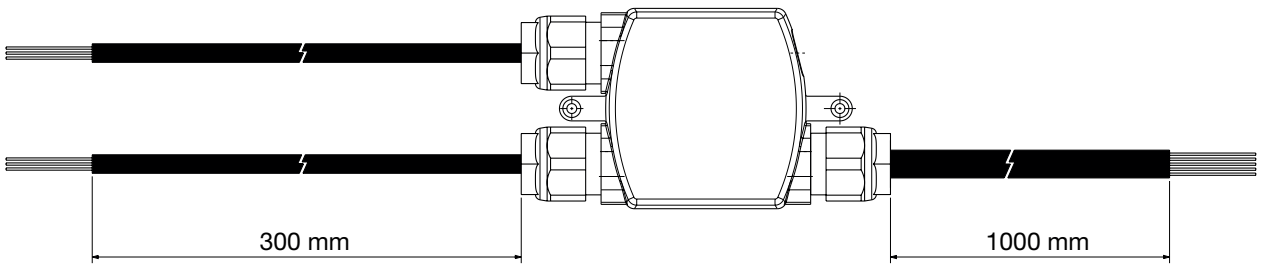
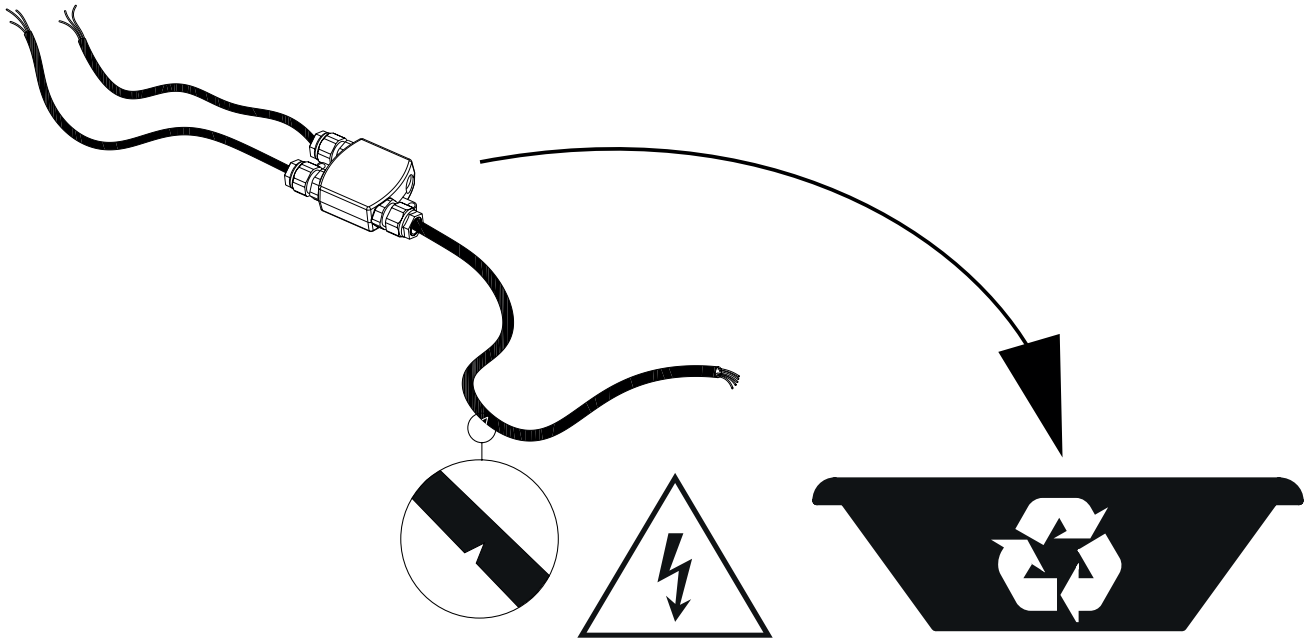

Punto di contatto indicato in adempimento ai fini delle direttive e regolamenti UE applicabili:  
*Contact details according to the relevant European Directives and Regulations:*

**GEWISS S.p.A. Via A.Volta, 1 IT-24069 Cenate Sotto (BG) Italy tel: +39 035 946 111 E-mail: [qualitymarks@gewiss.com](mailto:qualitymarks@gewiss.com)**



**+39 035 946 111**

8.30 - 12.30 / 14.00 - 18.00  
lunedì ÷ venerdì - monday ÷ friday



**+39 035 946 260**



**[sat@gewiss.com](mailto:sat@gewiss.com)**  
**[www.gewiss.com](http://www.gewiss.com)**