

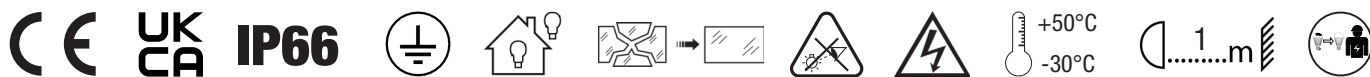

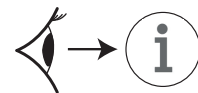

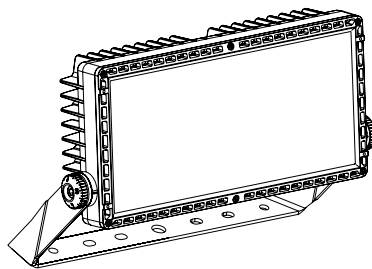





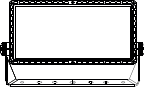

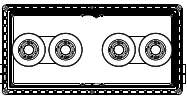

Smart [PRO]e

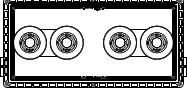
GEWISS

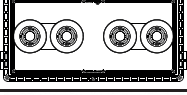

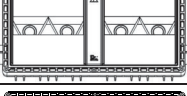
				I_{out}	U_{out}	t_a
	8	0,04 m ²	0,16 m ²	Max 1,4A	Max 340V [~]	Max 50°C

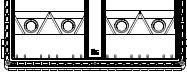

LED CCT			≤ 5700 K
Optics			RG1
		SN	2,5
		SM	2,5
		SW	2,5
		ALW	8
		ASW	8

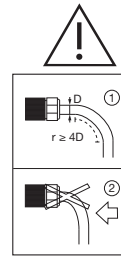
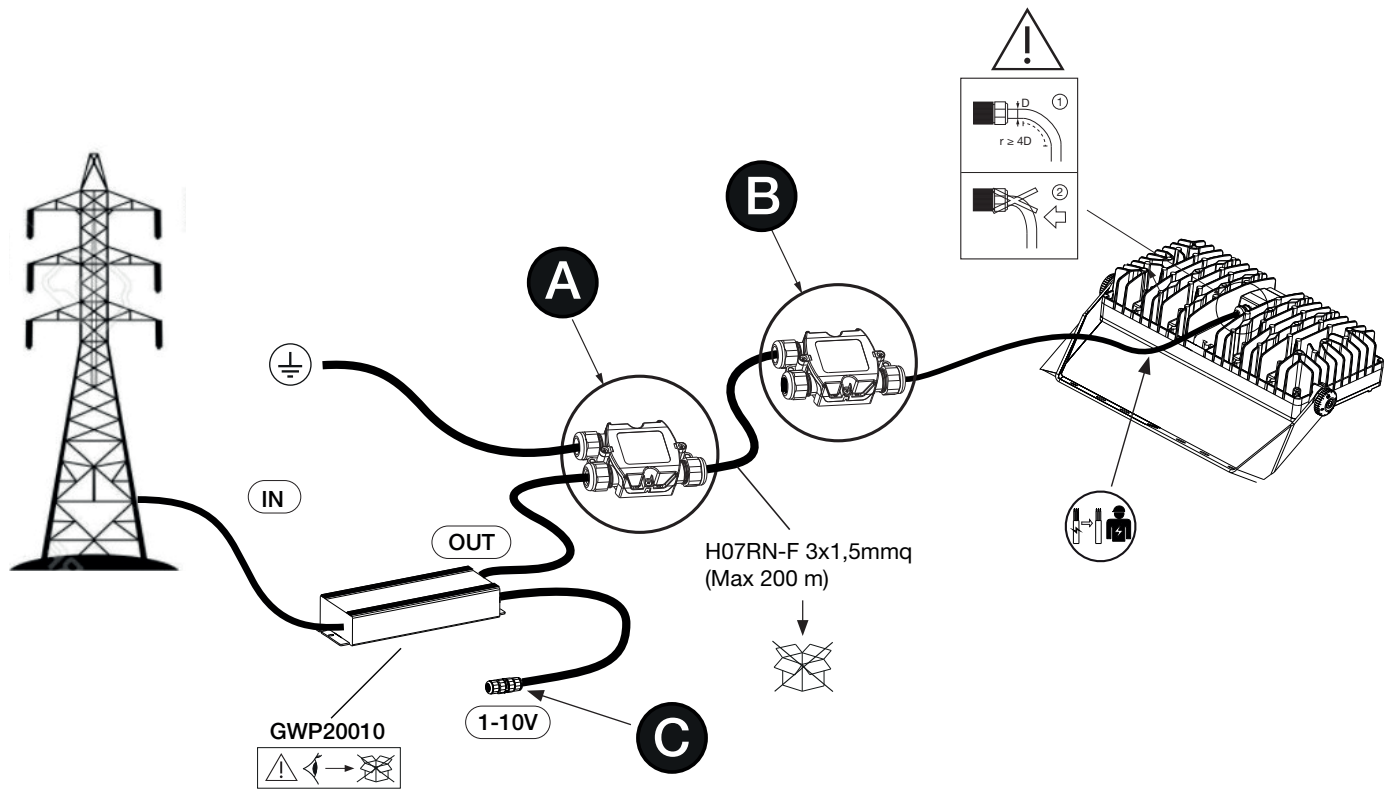

B GWP20113 →

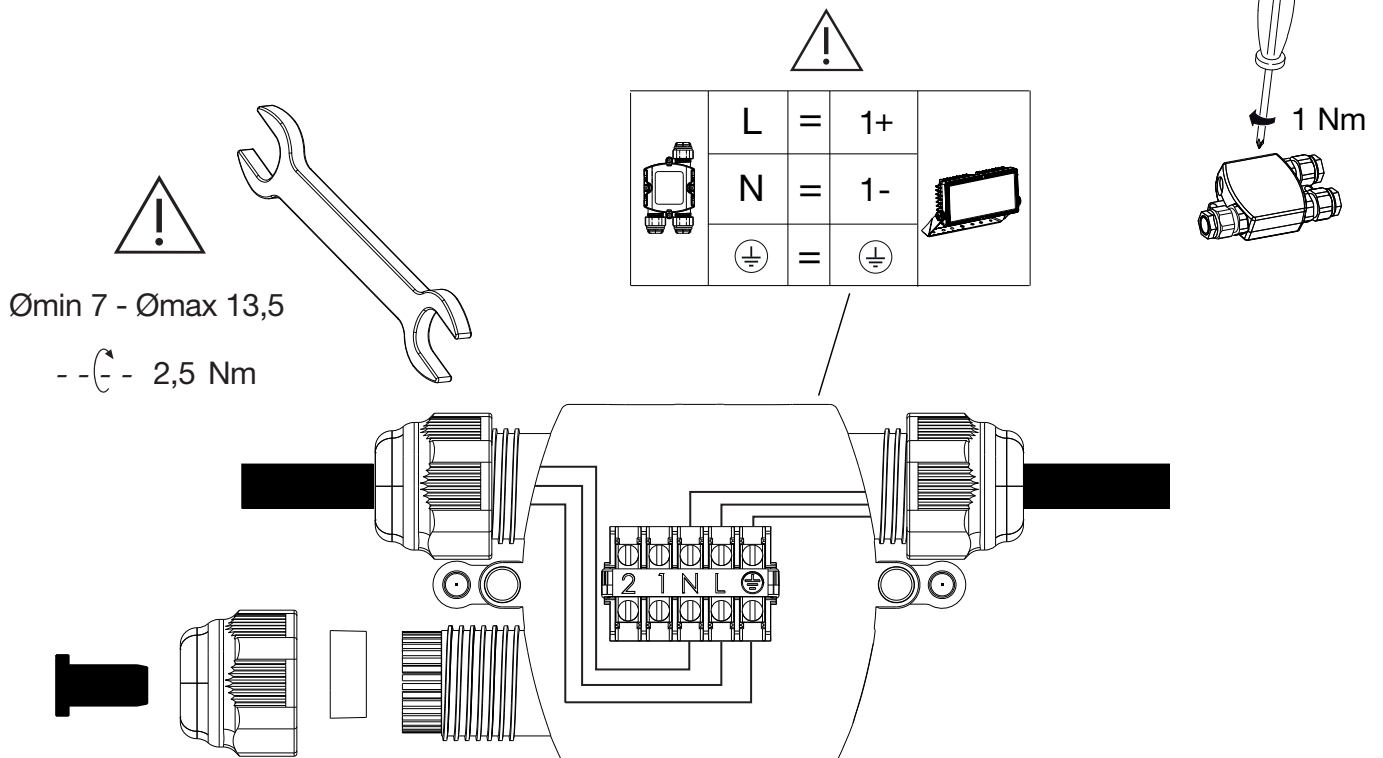



1-10V

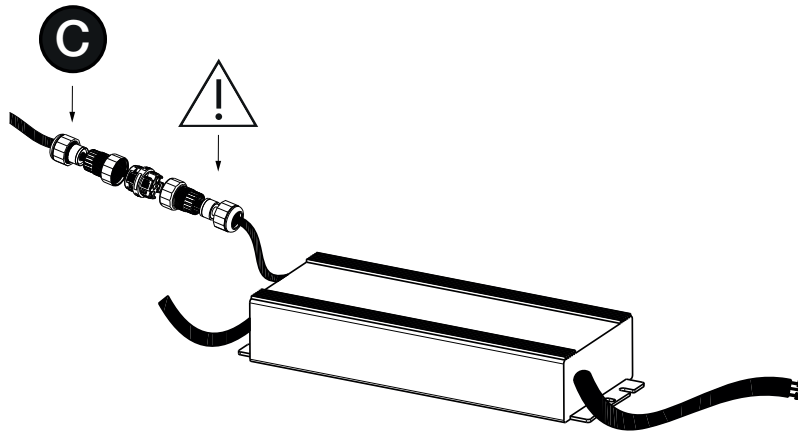

!

1-10V		
2	=	DIM-
3	=	DIM+

C

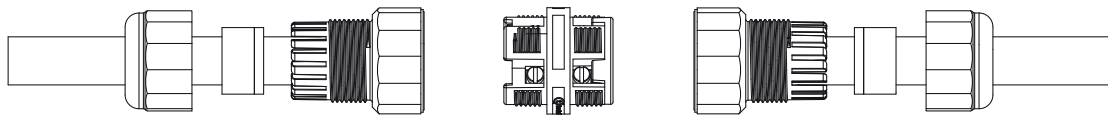

6 mm

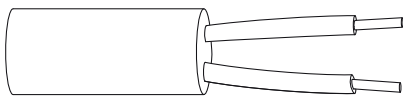

25 mm

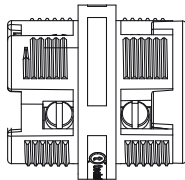

6 mm

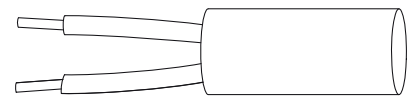

25 mm



😊 OK

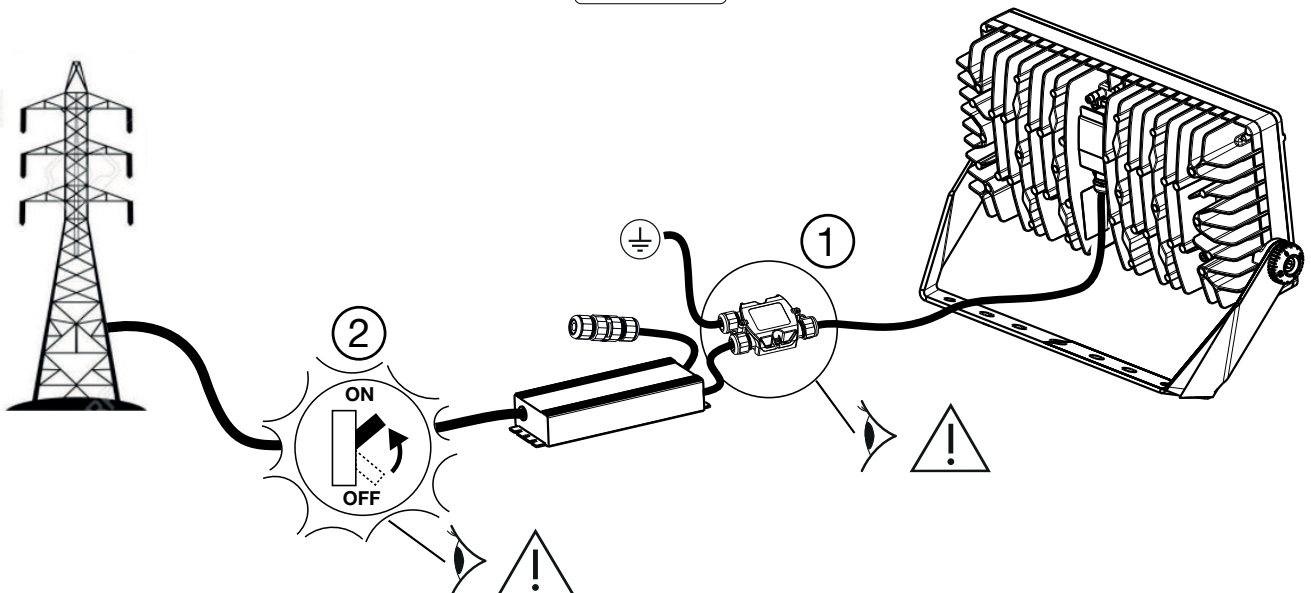

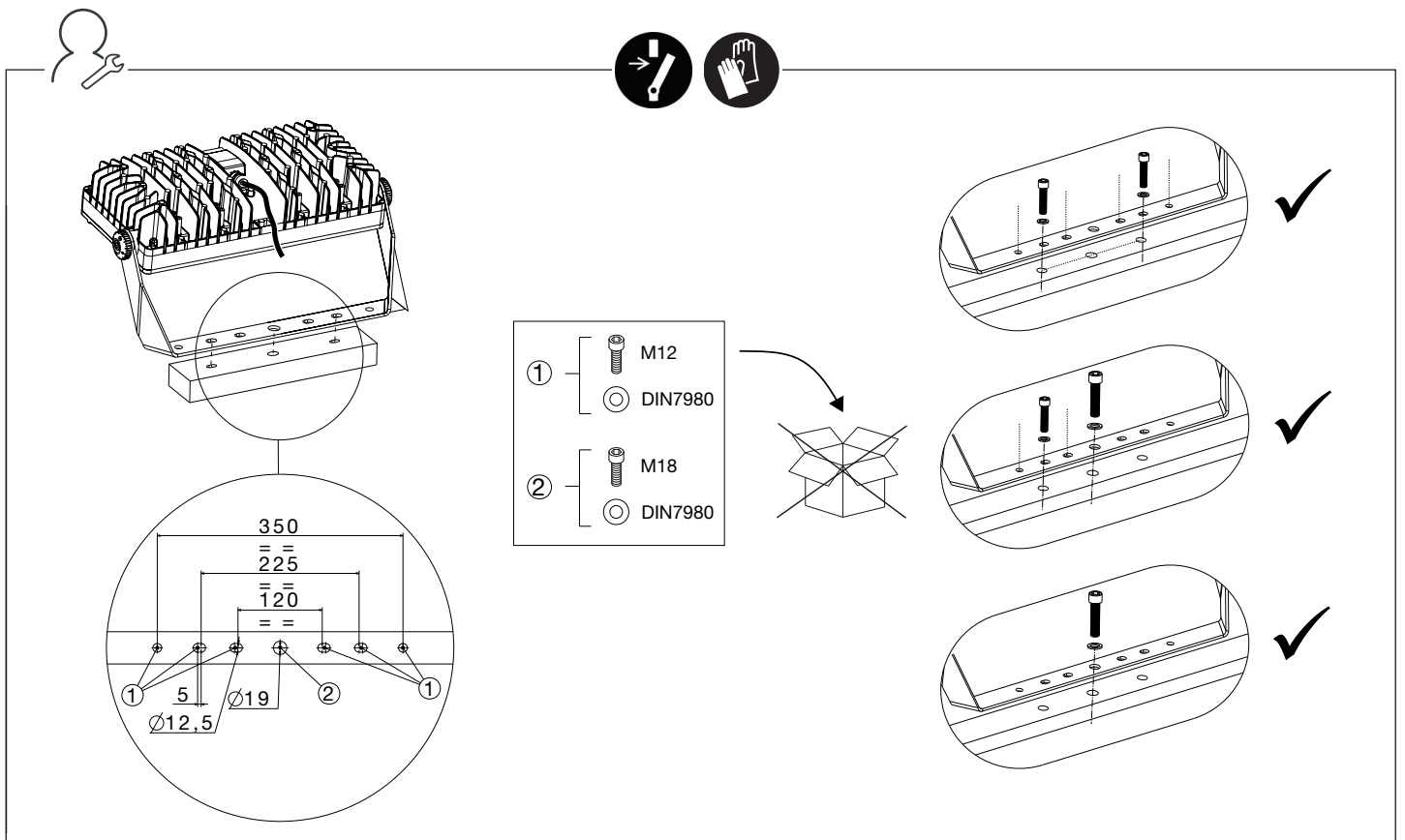
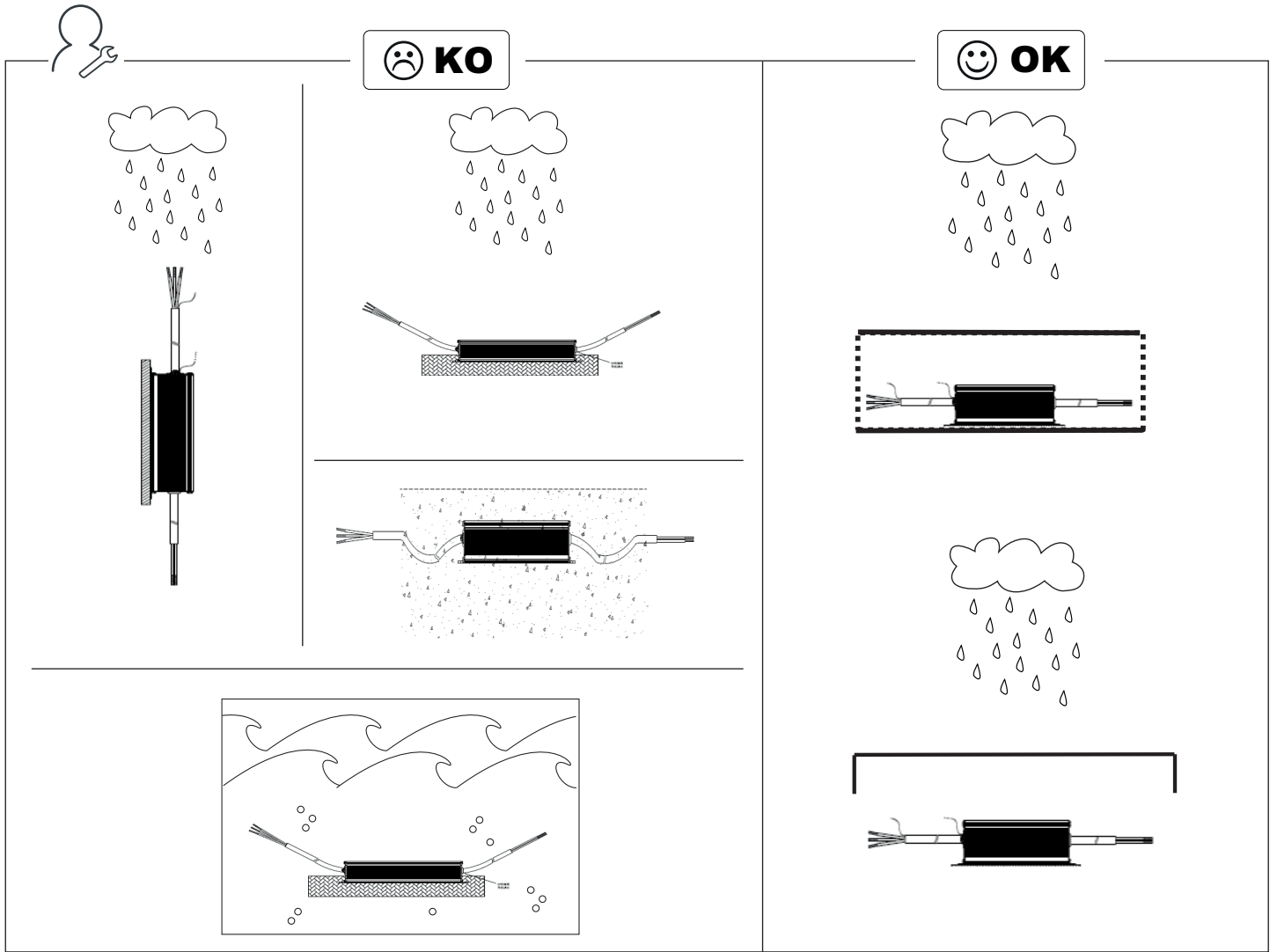

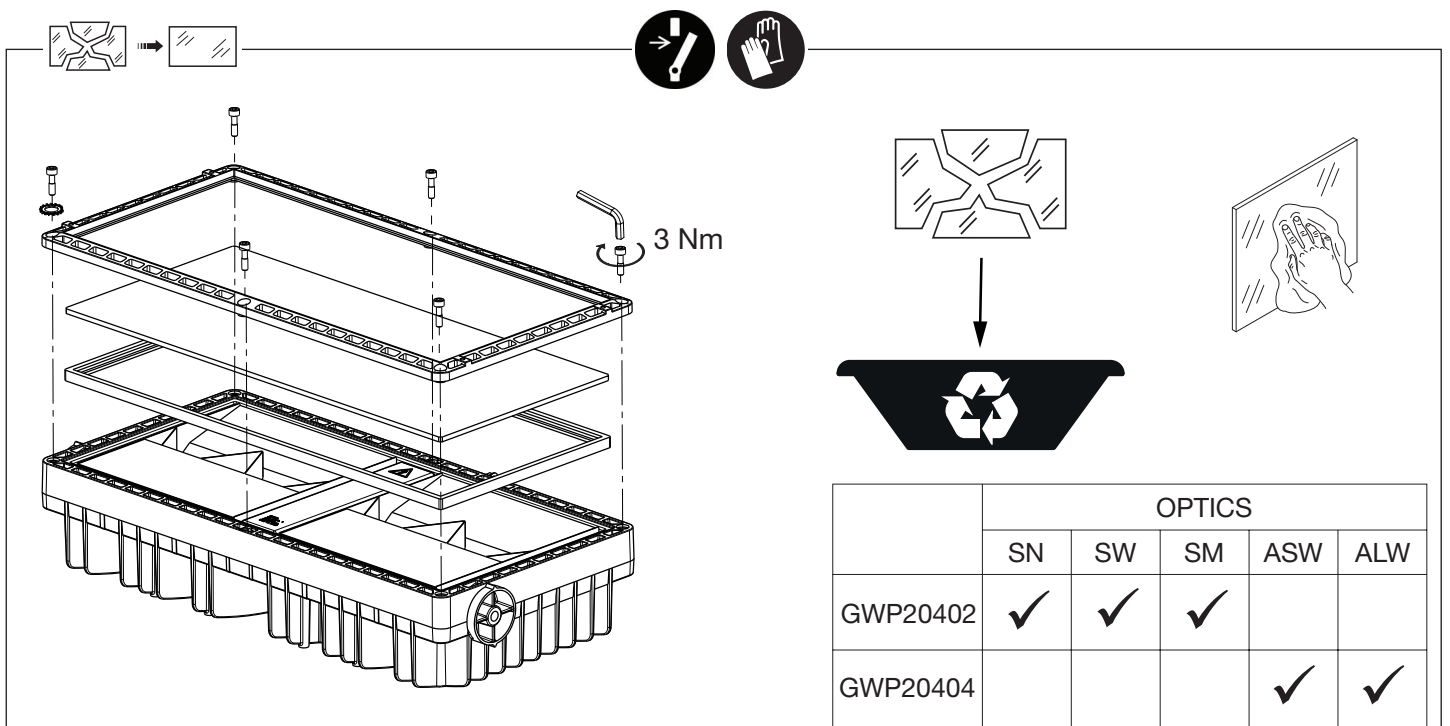
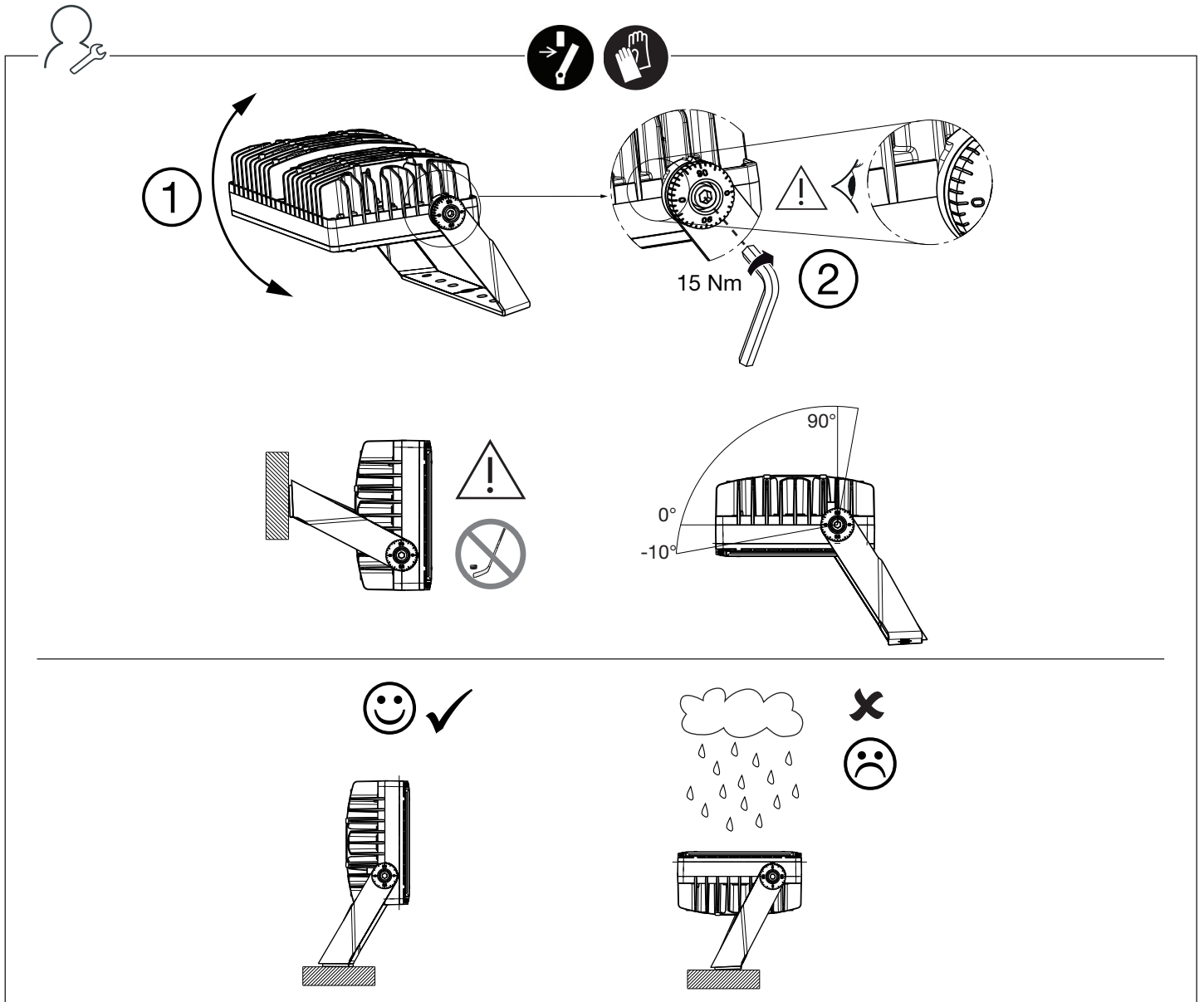

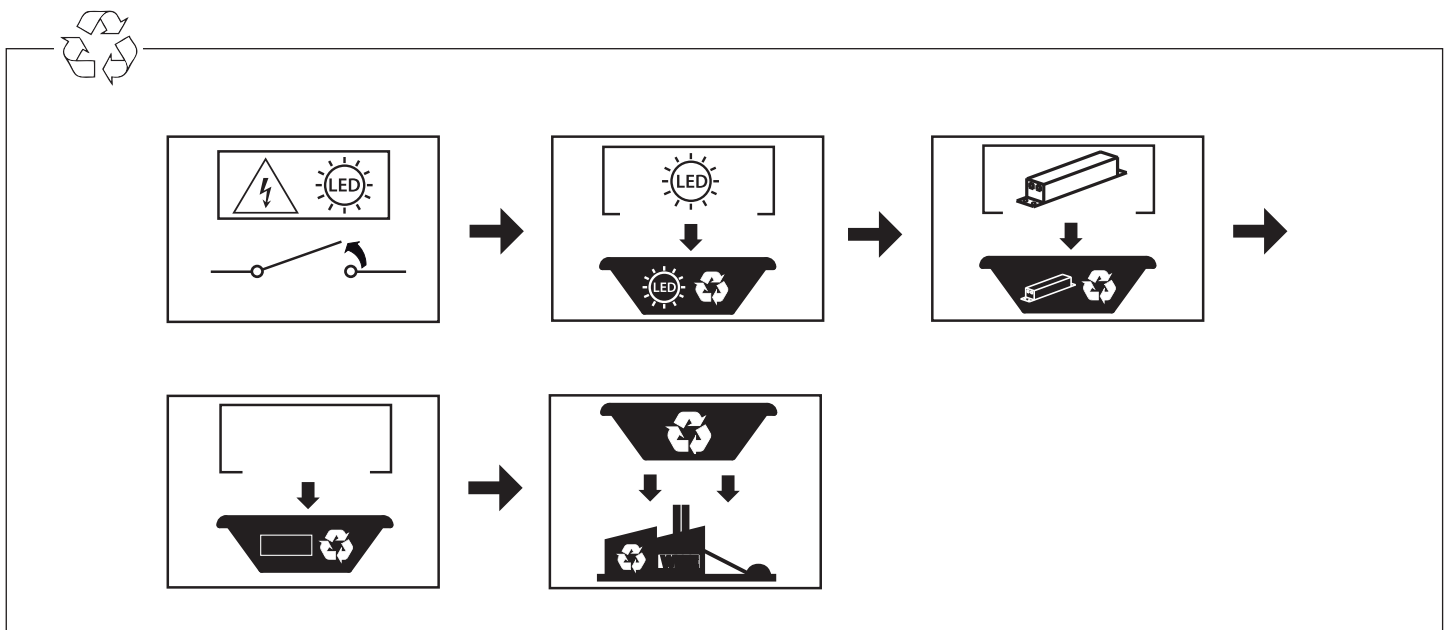
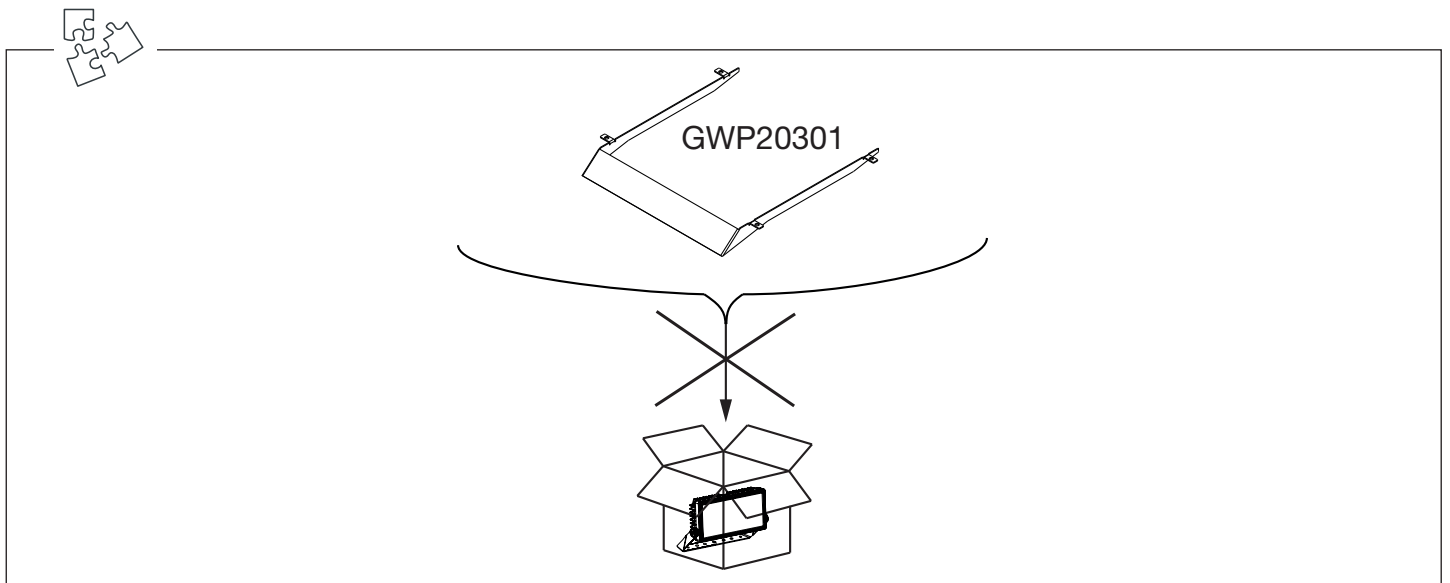
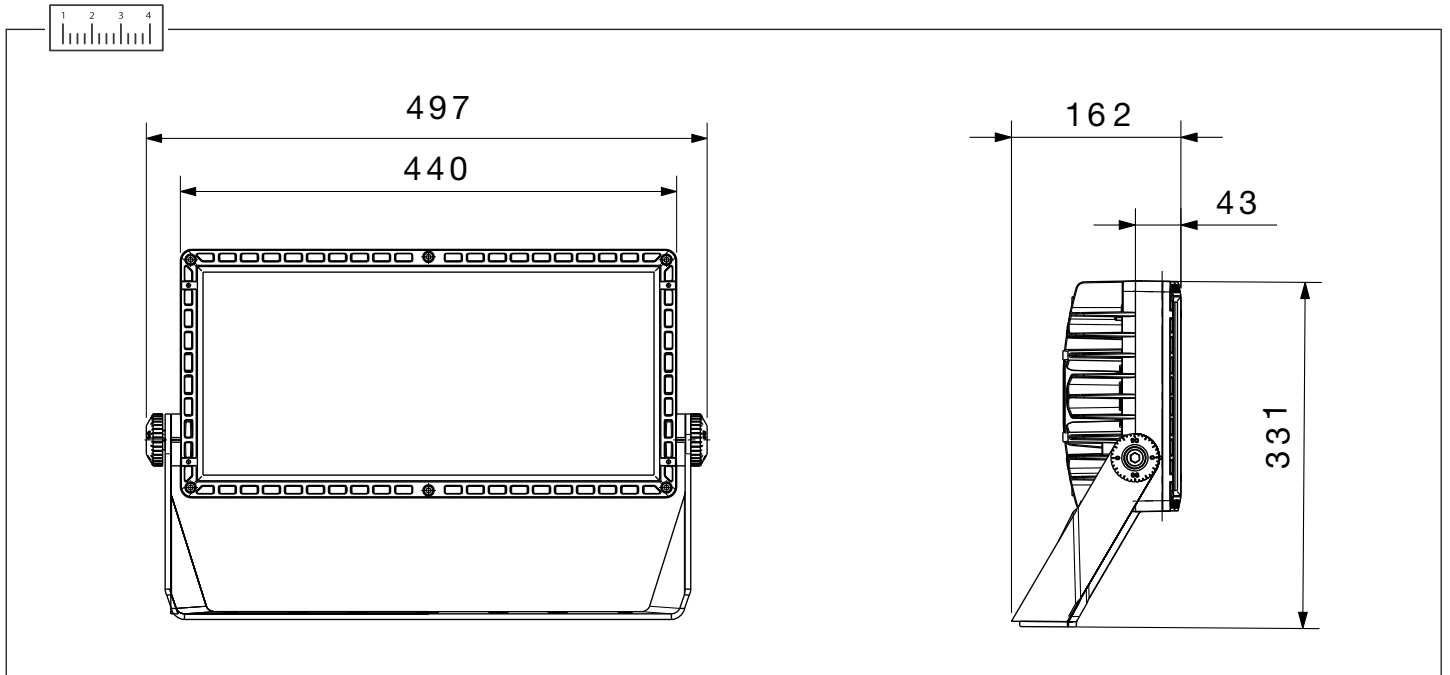

Punto di contatto indicato in adempimento ai fini delle direttive e regolamenti UE applicabili:
Contact details according to the relevant European Directives and Regulations:
GEWISS S.p.A. Via D.Bosatelli, 1 IT-24069 Cenate Sotto (BG) Italy tel: +39 035 946 111 E-mail: qualitymarks@gewiss.com

According to applicable UK regulations, the company responsible for placing the goods in UK market is:
GEWISS UK LTD - Unity House, Compass Point Business Park, 9 Stocks Bridge Way, ST IVES
Cambridgeshire, PE27 5JL, United Kingdom tel: +44 1954 712757 E-mail: gewiss-uk@gewiss.com



+39 035 946 111

8:30 - 12:30 / 14:00 - 18:00

lunedì - venerdì / monday - friday



www.gewiss.com

