

# Smart [PRO]e

# GEWISS

## GWP20010

### 1-10V

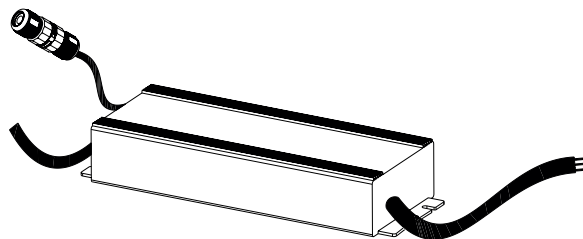

**IP66**



+50°C  
-30°C

	<b>V<sub>in</sub></b>	<b>I<sub>out</sub></b>	<b>U<sub>out</sub></b>
1-10V	220-240Vac	Max 1,4A	Max 340V <sup>~</sup>

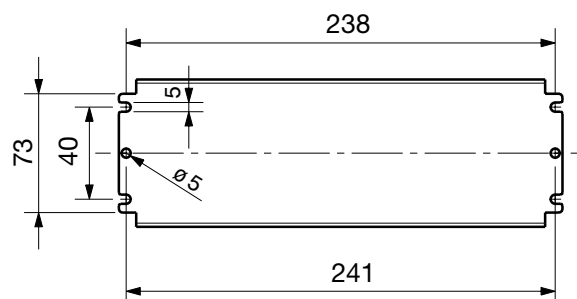
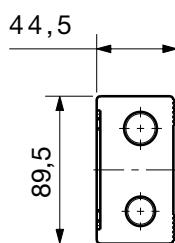
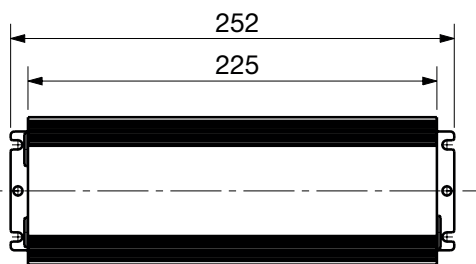

Max 2 kg

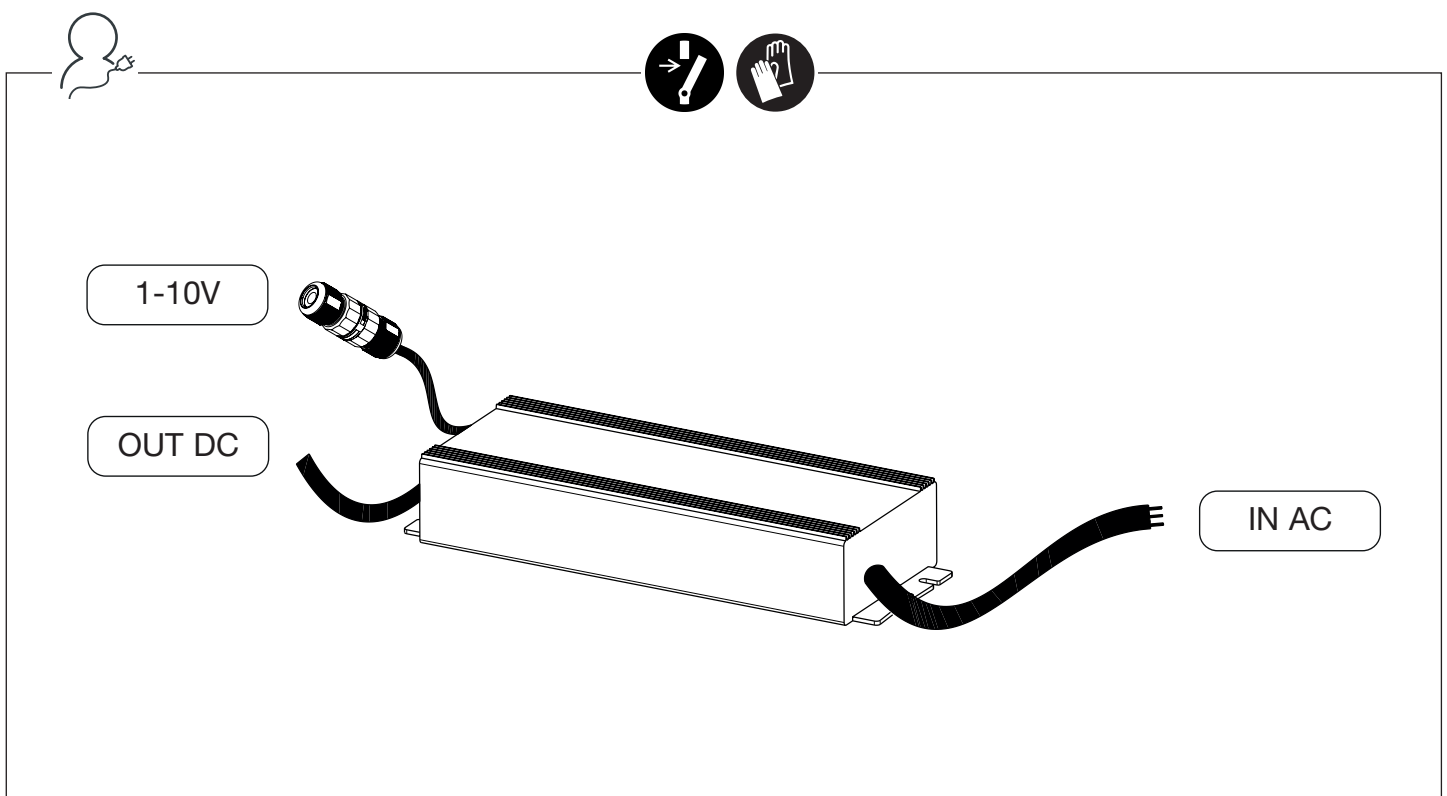
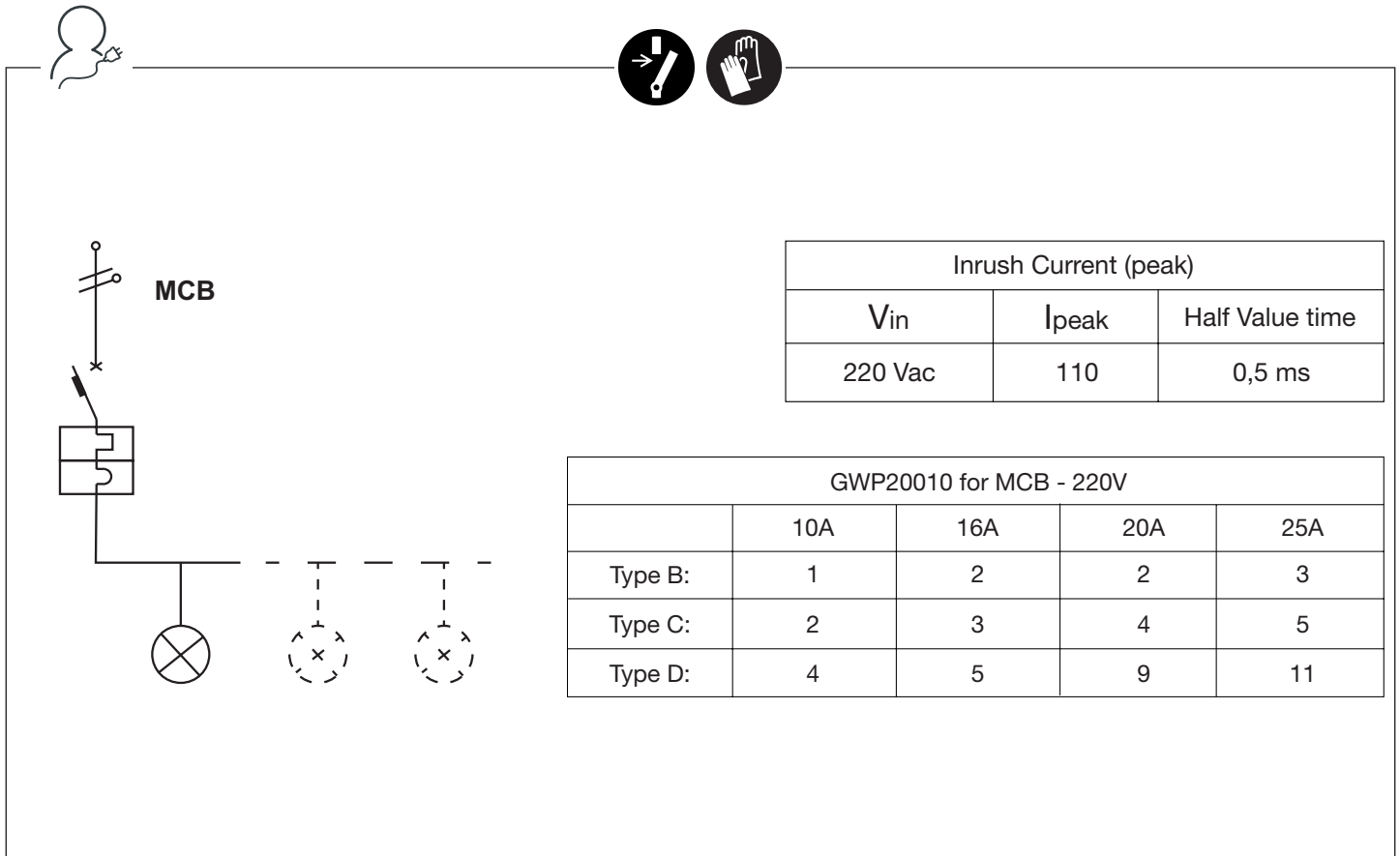



1-10V

A

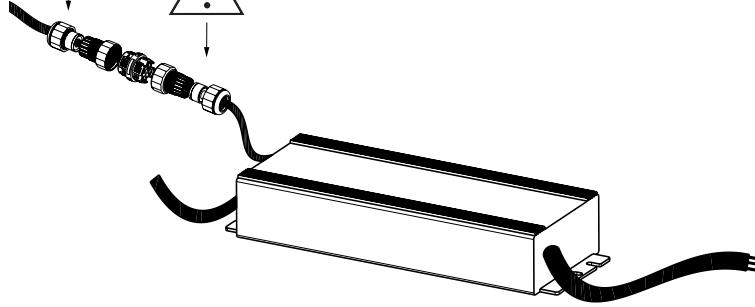

1-10V

2	=	-
3	=	+



A

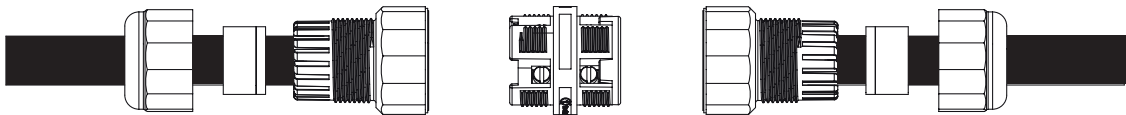

6 mm

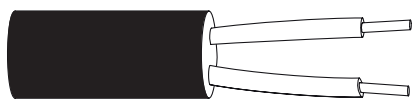

25 mm

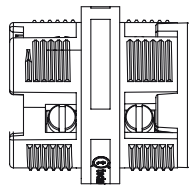
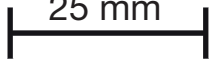

6 mm

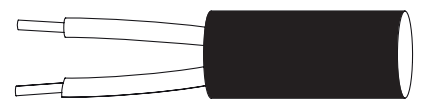

25 mm

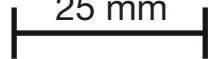





OUT

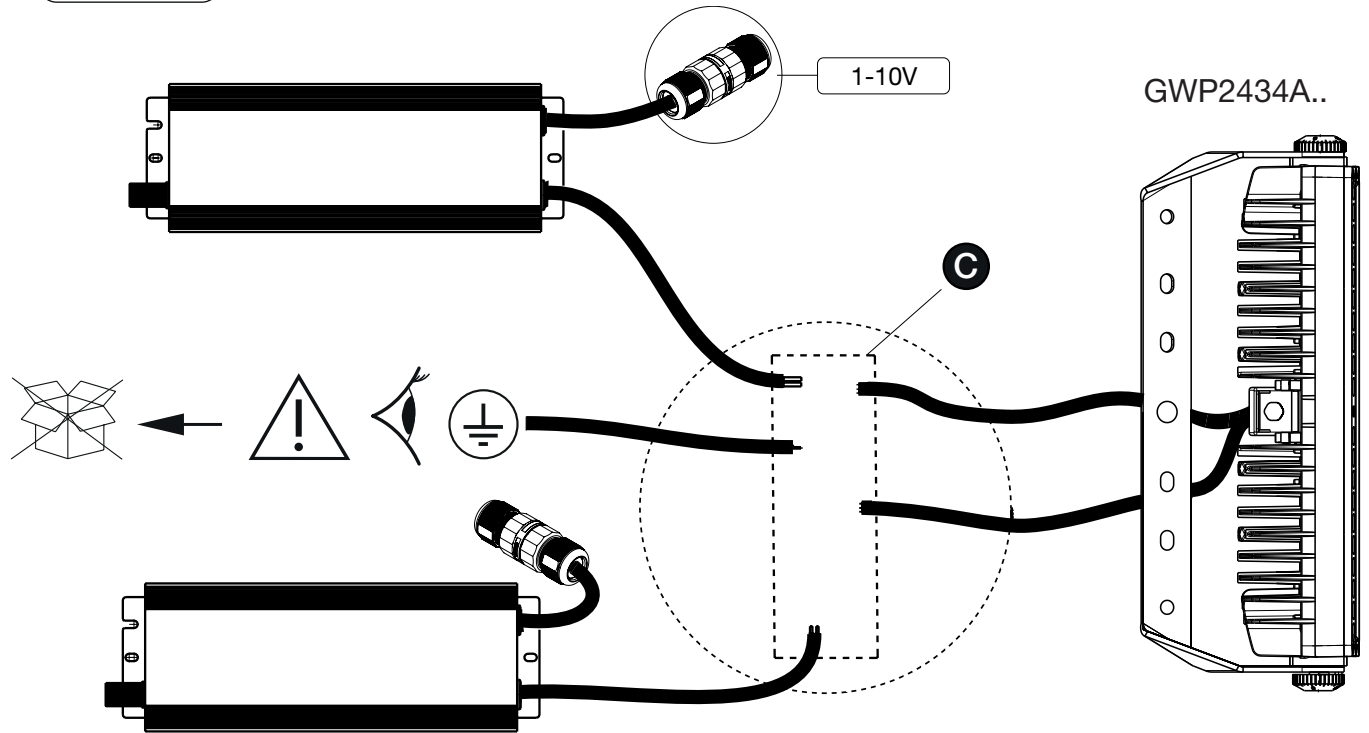

C

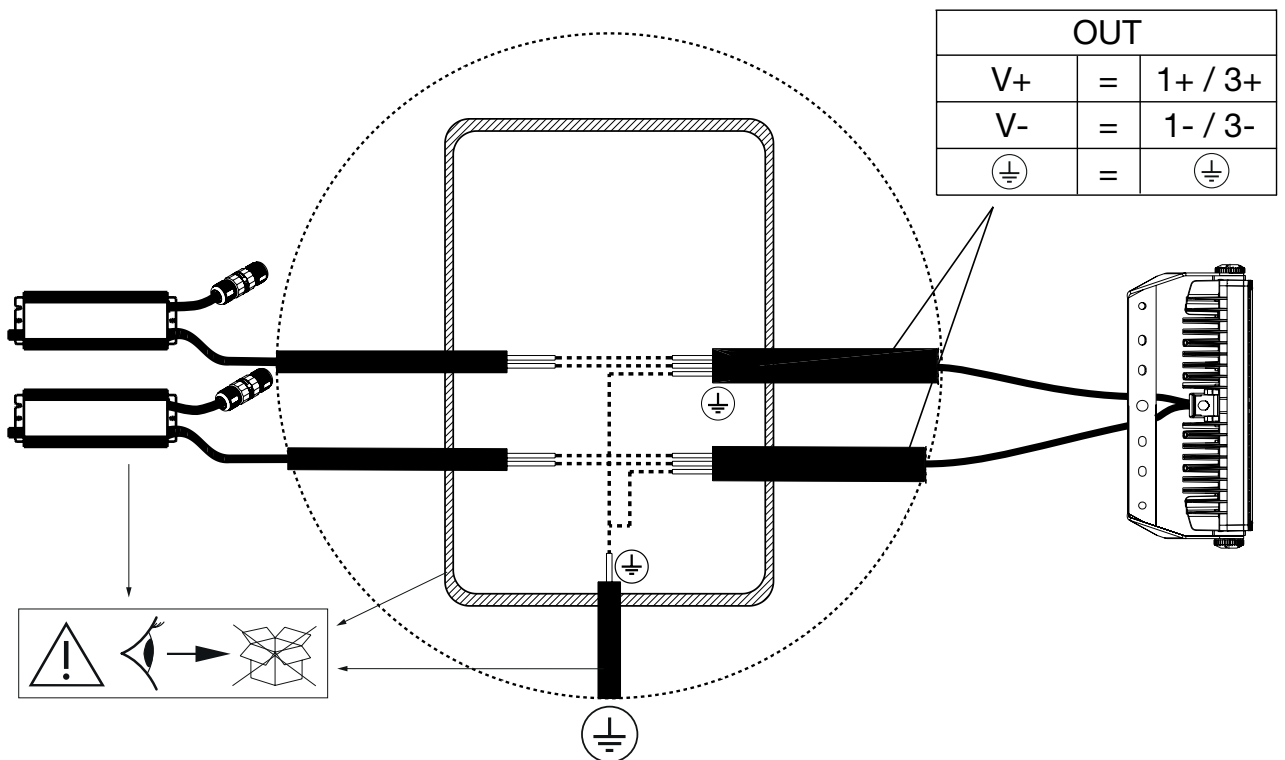

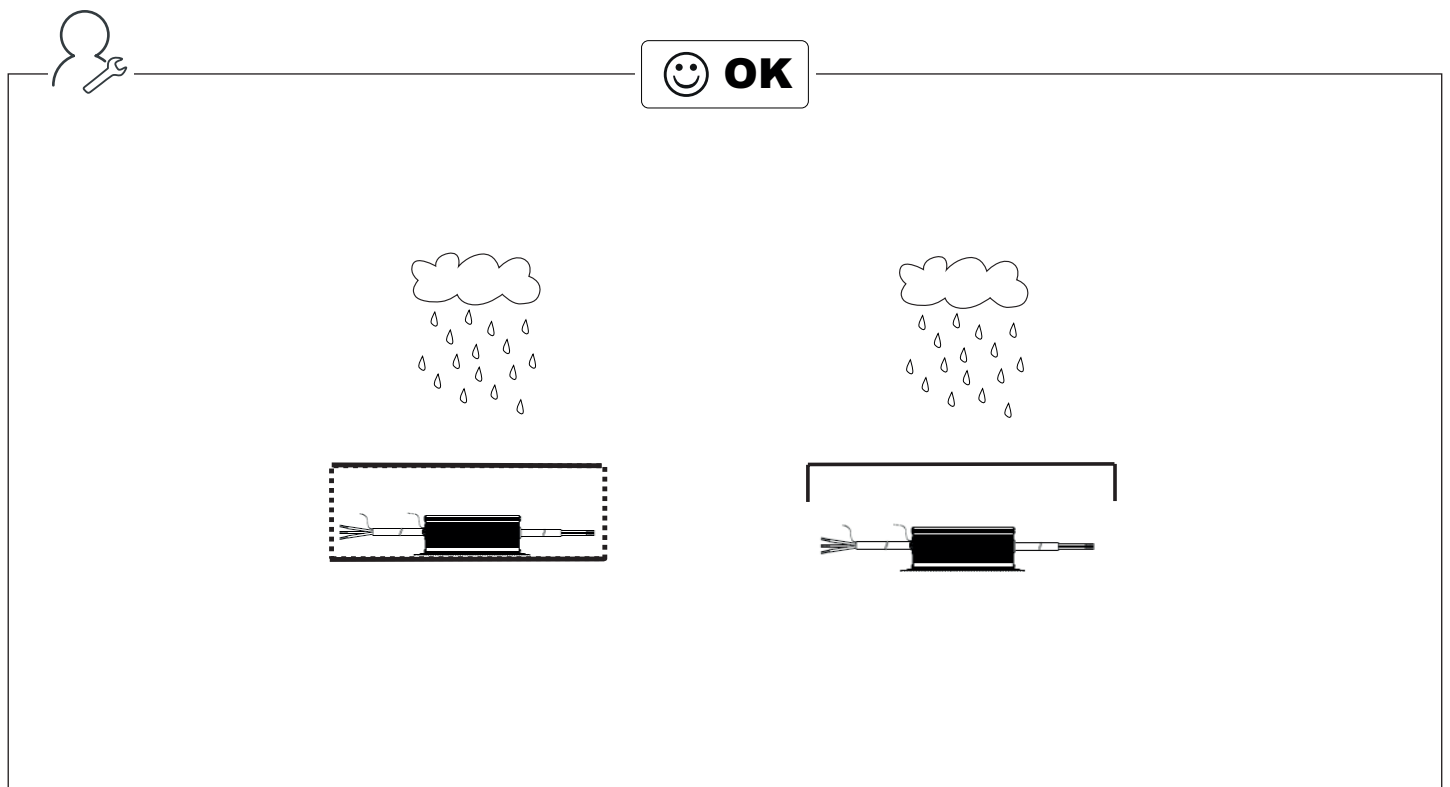
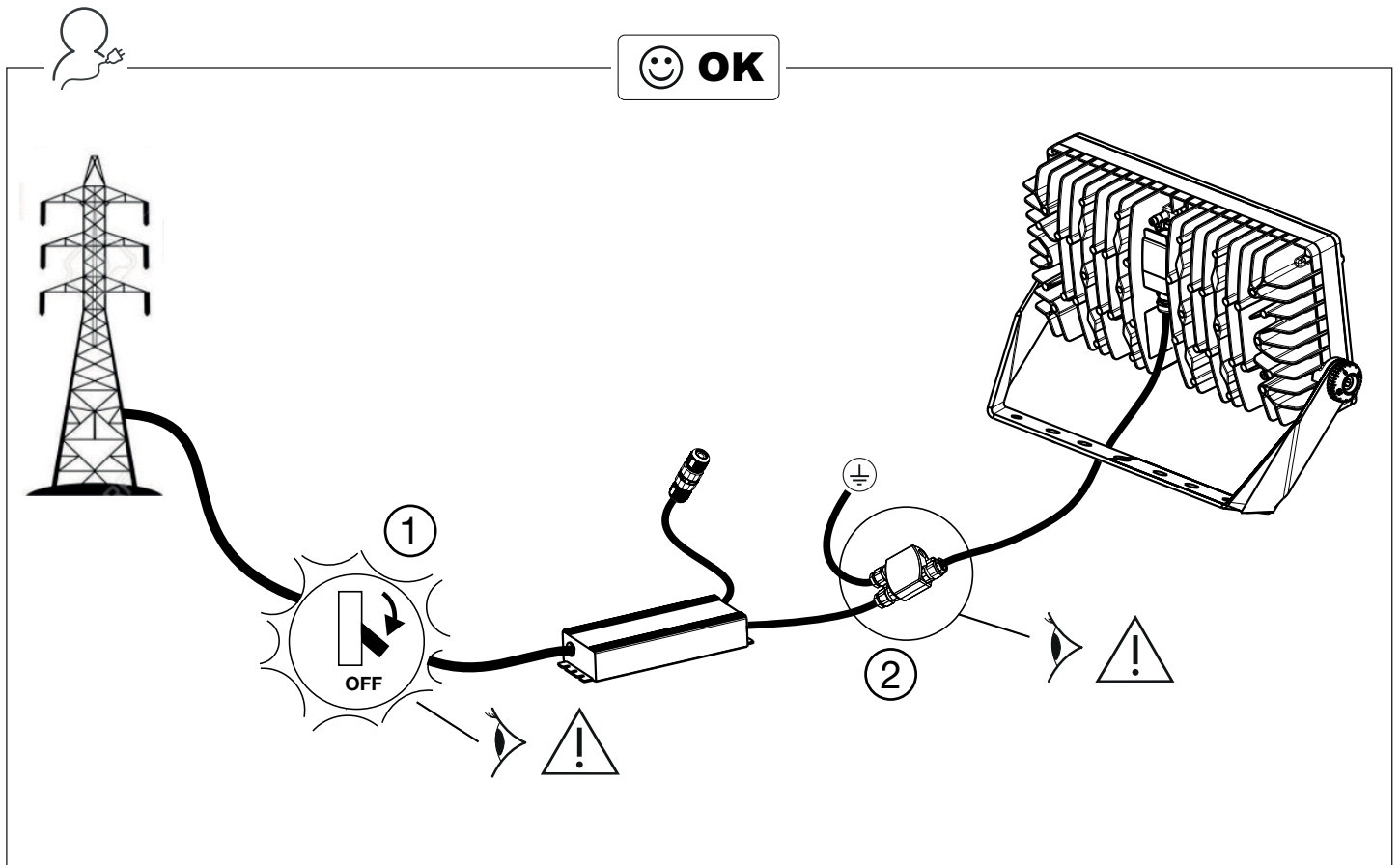



☹️ **KO**

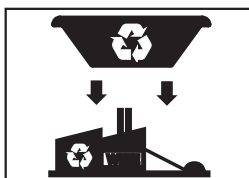
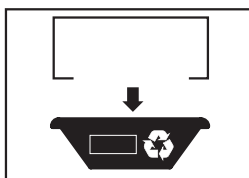
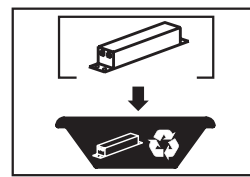
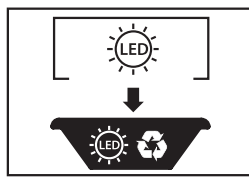
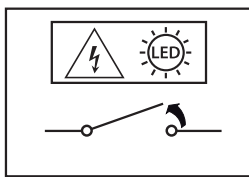
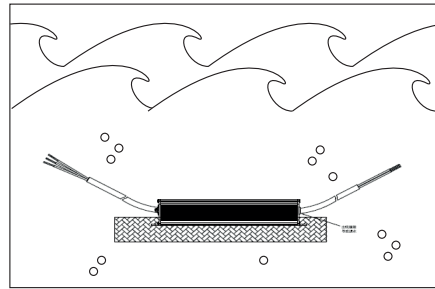
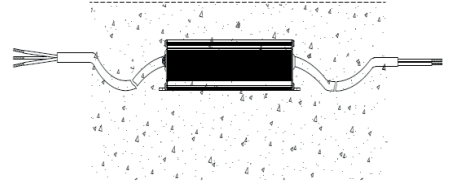

Punto di contatto indicato in adempimento ai fini delle direttive e regolamenti UE applicabili:  
*Contact details according to the relevant European Directives and Regulations:*  
GEWISS S.p.A. Via D.Bosatelli, 1 IT-24069 Cenate Sotto (BG) Italy tel: +39 035 946 111 E-mail: [qualitymarks@gewiss.com](mailto:qualitymarks@gewiss.com)

According to applicable UK regulations, the company responsible for placing the goods in UK market is:  
**GEWISS UK LTD - Unity House, Compass Point Business Park, 9 Stocks Bridge Way, ST IVES**  
Cambridgeshire, PE27 5JL, United Kingdom tel: +44 1954 712757 E-mail: [gewiss-uk@gewiss.com](mailto:gewiss-uk@gewiss.com)



**+39 035 946 111**  
8:30 - 12:30 / 14:00 - 18:00  
lunedì - venerdì / monday - friday



[www.gewiss.com](http://www.gewiss.com)

