

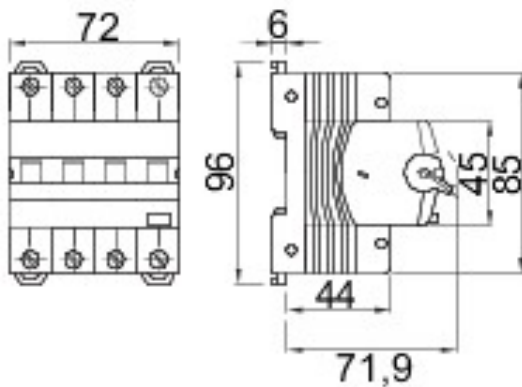

Omschrijving	AARDLEKSCHAKELAAR MET OVERSTROOMBEVEILIGING
Code	MDC 60
Aantal polen	4P
Aantal modules	4
Nominale stroom	32 A
Nominale restbedrijfsstroom	300 mA
Type	A[S]
Curve	C
Nominale spanning (EN/IEC 61009-1, 61009-2-1)	400/415 V
Energy limiting class	1

Standaard	IEC/EN 61009-1, IEC/EN 61009-2-1	Nominale frequentie (Hz)	50/60 Hz
Afschakelvermogen EN 61009-1 400 V (Icn)	6000 A	Afschakelvermogen EN 61009-1 (Ics)	1 x Icn
Afschakelvermogen EN 60947-2 400 V (Icu)	6 kA	Afschakelvermogen EN 60947-2 (Ics)	100% Icu
Isolatiespanning (Ui)	500 V	Immunitieitsniveau (8/20 µs)	3000 A
Nominale stoot-houdspanning (Uimp)	4 kV	Overspannings-categorie	III
Elektrische weerstand	10000	Mechanische weerstand	20.000
Doorsnede starre kabel	<=1x35 - <=2x16 - <=1x16+2x10 mm²	Doorsnede flexibele kabel	<=1x35 - <=2x16 - <=1x16+2x10 mm²
Dubbel verbinding	JA (alleen stroomafwaarts)	Nominaal aandraaimoment	2 Nm
Bedrijfstemperatuur	-25 +60° C (derating of In with T>30° C)	Opslagtemperatuur	-40 +70 °C
Hulpmiddelen - compatibiliteit	Ja	ReStart compatibiliteit	Ja
Montage-positie	Elke		

### DIMENSIONAL



### WIRING DIAGRAM

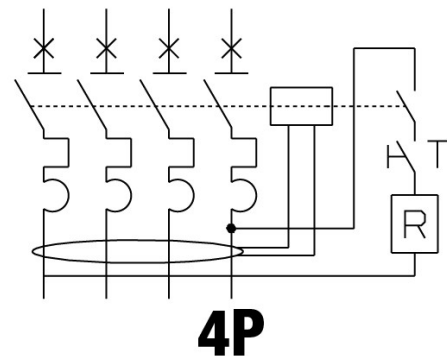

### STANDARDS/APPROVALS



