

ROAD [5] Range



Straatverlichtingsarmatuur met HIGH POWER LED, bestaande uit kap, frame en paalkoppeling met een laag kopergehalte EN AB 46100 gietaluminium met polyester poedercoating. Geschikt voor paalkop en zijbeugel in stappen van 5 graden kantelbaar. Open- en sluitsysteem met geïntegreerde fronthendel. Getemperd afdekglas (4 mm dik). Kabelingang PG13,5. Veiligheidsmes. Bekabelingsplaat in PA6.6+GF. Printplaat (PCB) met metalen kern. Optisch systeem van gemetalliseerd polycarbonaat. Overspanningsbeveiliging max. 10 kV (gemeenschappelijke modus). Kan worden gebruikt bij een omgevingstemperatuur van max. 50 ° C maar met geringere stromen zoals vermeld in de technische handleiding.

GENERAL INFORMATION

Context	Street and parking lighting
Luminaire	LED Road Equipment
Toepassing	Extern
Unique digital code (Datamatrix)	Currently not present
Kleur	Grafietgrijs
Type lichtbron	LED
System power	74 W @ 1A
LED Lifetime	L90B10(Tq25°C)>115.000h; L90B10(Tq40°C)=115.000h
Gewicht (kg)	6.6
Garantie	5 jaar
Opslagtemperatuur	-
Operating temperature	-25 +40 °C

OPTIC AND ILLUMINATING FEATURES

Optiek	HUGE
Unified Glare Rating	G*4 - ULOR = 0
Lumenvermogen (lm)	8100
Efficacy (lm/W)	109
Kleurtemperatuur	3000 K
Colour Rendering Index	CRI>70
Standard Deviation Colour Matching	SDCM = 5
Photobiological Risk Class	RG0
Standaard	EN 60598-2-3, EN 60598-1 IEC/TR 62778

MATERIALS

Body	Gietaluminium
Type plaat	4mm thick flat tempered glass
Optic	Silver PVD aluminium reflector
Gasket	Anti-aging silicone
Locking Hook	Integrated front handle
External screw	Roestvrij staal

ELETRICAL AND LIGHTING FEATURES

Voedingsspanning	220 - 240 V
Nominale frequentie (Hz)	50 / 60
Driver failure rate	F10=100.000h Tq25°C/75.000h Tq40°C
Driver	Included
Overvoltage protection	DM 10KV / CM 10KV
Control System	Bi-power met zelfleerfunctie

INSTALLATION AND MAINTENANCE

Mounting and installation	Pole Head - Outreach
Tilt	-20° + +10° zijbeugel - -10° + +20° paalbeugel
Wiring	Scheidingsschakelaar
Bevestiging	Pole Head - Outreach
Light source replaceability	By professional
Controlgear replaceability	By professional

STANDARDS AND APPROVALS

Classificering	-
Toestel met verlaagde oppervlaktetemperatuur	-
DIN 18032-3-certificering	-
IPEA	-
Isolatieklasse	II
IP-graad	IP66
Stootbestendigheid	IK08
Glow Wire Test	-

Driver Box	Ingebouwd
Maximum surface exposed to the wind	0.15 m²

DIMENSIONAL

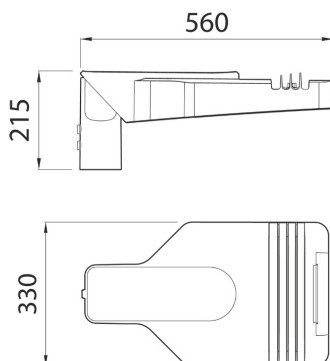

PHOTOMETRIC DISTRIBUTION

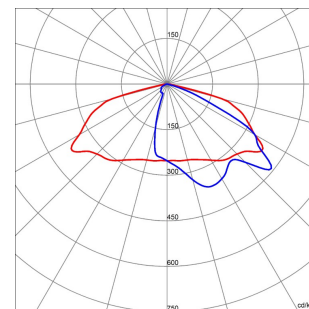

ROAD [5] Range

TECHNICAL SYMBOLOGY



0.15 m²



IP
IP66

IK
IK08

GWT
-

STANDARDS/APPROVALS

**UK
CA**

