

On request



ELIA FL is a LED outdoor floodlight available in low, medium and high power versions for lighting external industrial areas, such as car parks and walkways or driveways. It can be mounted on surfaces, ceilings or on the ground using the adjustable steel bracket supplied with the device, or in the pole head version, courtesy of the dedicated accessory for poles with a diameter of up to 61mm. Crafted from black powder-coated die-cast aluminium, it is available in four sizes and powers, with integrated power supply in the On/Off or DALI options, three types of optic (30°, 60° and asymmetrical) with a colour temperature of 4,000K (neutral white) and a colour rendering index of more than 80. Tough and durable, ELIA FL has been designed to withstand surges of up to 10KV and temperature variations from -30 °C to + 50 °C, and offers protection from water and dust penetration of up to level IP66 and from shocks and impacts of up to level IK08. ELIA FL is quick and easy to install thanks to its limited weight and adjustable bracket.

GENERAL INFORMATION		OPTIC AND ILLUMINATING FEATURES	
Context	Industry, Logistic, Façade, Sport	Optiek	60°
Luminaire	LED luminaire with small, mid and high lumen power	Unified Glare Rating	ULOR = 0%
Toepassing	Binnenshuis / buitenshuis	Lumen-vermogen (lm)	6600
Unique digital code (Datamatrix)	Currently not present	Efficacy (lm/W)	132
Kleur	Zwart	Kleur temperatuur	4000 K
Type lichtbron	LED	Colour Rendering Index	CRI 80
System vermogen	50 W	Standard Deviation Colour Matching	SDCM = 5
LED Lifetime	L80B50 (Tq25°) = 89.000h	Photobiological Risk Class	RG0
Gewicht (kg)	2.6	Standaard	-
Garantie	5 jaar	ELETRICAL AND LIGHTING FEATURES	
Opslagtemperatuur	-40° +85°	Voedings-spanning	100-240 V
Operating temperature	-30° +50°	Nominale frequentie (Hz)	50 / 60
MATERIALS		Driver	Included
Body	Gietaluminium	Driver failure rate	F10 = 80.000h Tq25°C
Type plaat	Flat silked tempered glass 4mm thick with Gewiss logo	Overvoltage protection	Overvoltage protection 6-4kV
Optic	With high efficiency optic system	Control System	AAN UIT
Gasket	-	INSTALLATION AND MAINTENANCE	
Locking Hook	-	Mounting and installation	Ceiling - Wall - Floor
External screw	Roestvrij staal	Tilt	With adjustable bracket assembled
Colour	Powder coating	Wiring	With power cable
STANDARDS AND APPROVALS		Bevestiging	-
Classificering	-	Light source replaceability	By professional
Toestel met verlaagde oppervlaktetemperatuur	-	Controlgear replaceability	By professional
DIN 18032-3-certificering	-	Driver Box	Ingebouwd
IPEA	-	Maximum surface exposed to the wind	0.05 m²
Isolatie-klasse	I		-
IP-graad	IP66		-
Stootbestendigheid	IK08		-
Glow Wire Test	750 °C		-

### DIMENSIONAL

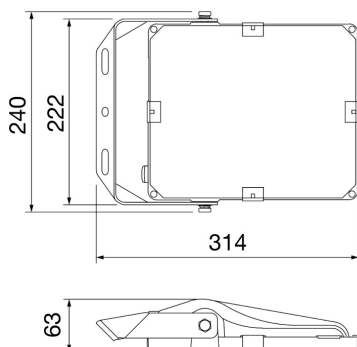

### PHOTOMETRIC DISTRIBUTION

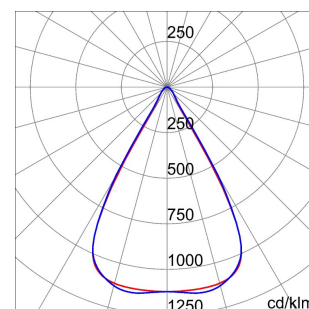

On request

### TECHNICAL SYMBOLOGY



**IP**  
IP66

**IK**  
IK08

**GWT**  
750 °C

### STANDARDS/APPROVALS

