

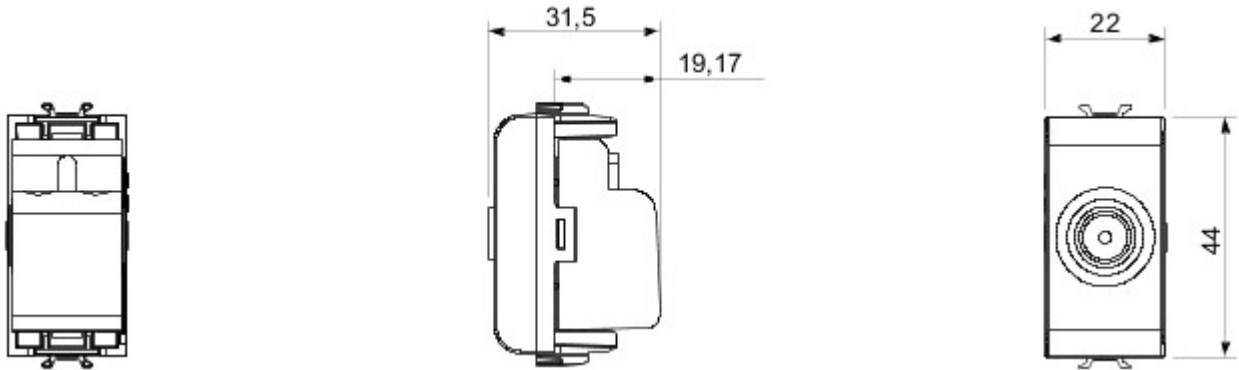

Wide range of control devices, sockets for power supply (conforming to national and international standards) signal pick-up, climate control, comfort management, technical alarm signalling and emergency lighting management. The ChoruSmart modular devices are available in five colours, glossy white, satin white, natural beige, satin black and lacquered titanium and in various sizes from 1/2, 1, 2 and 3 modules. Thanks to the mounting supports for rectangular, square and round boxes, endless combinations can be created with the ChoruSmart range of plates.

Categorie	TV-contactdoos	Omschrijving	Doorsteekstelsysteem
Kleur	Satin White	Verzwakking	10 dB
Frequentie	5-2400 MHz	Plaat	Klasse A
Voor connector type	IEC-mannelijk	Standaard	EN 60728-4; IEC 61169-2
Aantal modules	1	Cable fixing	Met schroef
Case	Pressure casting zamak metal body	Electrocod	0131
Materiaal	Technopolymeer		

### DIMENSIONAL



### STANDARDS/APPROVALS



GEWISS S.p.A. Via A. Volta, 1  
24069 Cenate Sotto - Bergamo - Italy  
tel. +39 035 94 61 11 fax +39 035 94 69 09

www.gewiss.com  
sat@gewiss.com  
Last update 17/07/2024

Data, measures, designs and pictures are shown only as informative purposes, and could be changed without previous notice